



COP410L/COP411L/COP310L/COP311L Single-Chip N-Channel Microcontrollers

General Description

The COP410L and COP411L Single-Chip N-Channel Microcontrollers are members of the COPSTM family, fabricated using N-channel, silicon gate MOS technology. These Controller Oriented Processors are complete microcomputers containing all system timing, internal logic, ROM, RAM and I/O necessary to implement dedicated control functions in a variety of applications. Features include single supply operation, a variety of output configuration options, with an instruction set, internal architecture and I/O scheme designed to facilitate keyboard input, display output and BCD data manipulation. The COP411L is identical to the COP410L, but with 16 I/O lines instead of 19. They are an appropriate choice for use in numerous human interface control environments. Standard test procedures and reliable high-density fabrication techniques provide the medium to large volume customers with a customized Controller Oriented Processor at a low end-product cost.

The COP310L and COP311L are exact functional equivalents but extended temperature versions of COP410L and COP411L respectively.

The COP401L should be used for exact emulation.

Features

- Low cost
- Powerful instruction set
- 512 x 8 ROM, 32 x 4 RAM
- 19 I/O lines (COP410L)
- Two-level subroutine stack
- 16 μ s instruction time
- Single supply operation (4.5V–6.3V)
- Low current drain (6 mA max)
- Internal binary counter register with MICROWIRE™ serial I/O capability
- General purpose and TRI-STATE® outputs
- LSTTL/CMOS compatible in and out
- Direct drive of LED digit and segment lines
- Software/hardware compatible with other members of COP400 family
- Extended temperature range device
 - COP310L/COP311L (–40°C to +85°C)

Block Diagram

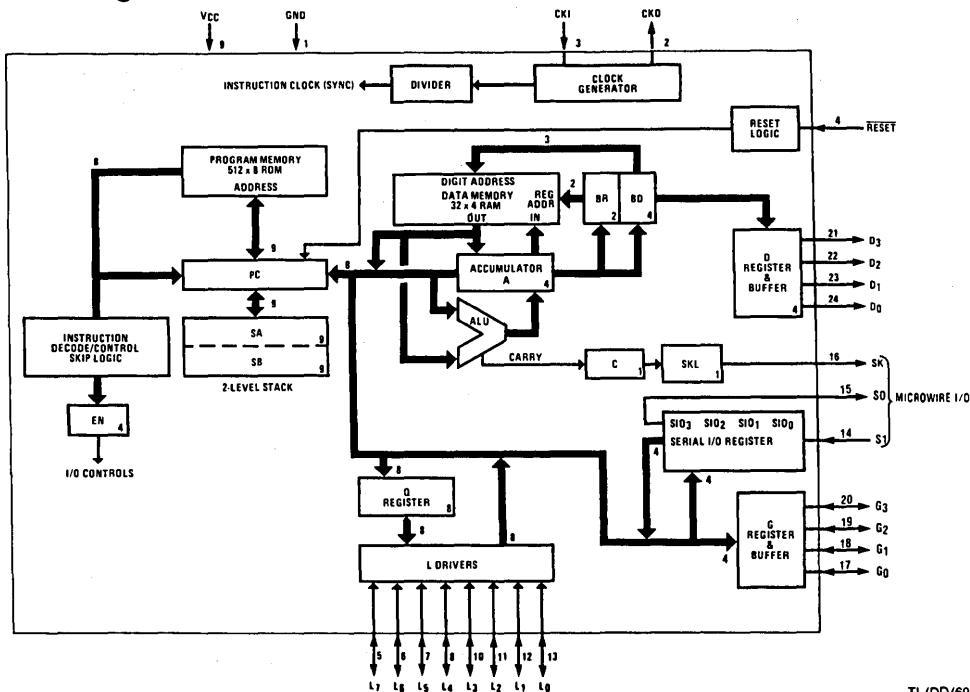

FIGURE 1. COP410L

TL/DD/6919-1

COP410L/COP411L

Absolute Maximum Ratings

If Military/Aerospace specified devices are required, please contact the National Semiconductor Sales Office/Distributors for availability and specifications.

Voltage at Any Pin Relative to GND	-0.5V to +10V
Ambient Operating Temperature	0°C to +70°C
Ambient Storage Temperature	-65°C to +150°C
Lead Temperature (Soldering, 10 seconds)	300°C

Power Dissipation	
COP410L	0.75W at 25°C 0.4W at 70°C
COP411L	0.65W at 25°C 0.3W at 70°C
Total Source Current	120 mA
Total Sink Current	100 mA

Note: Absolute maximum ratings indicate limits beyond which damage to the device may occur. DC and AC electrical specifications are not ensured when operating the device at absolute maximum ratings.

DC Electrical Characteristics $0^{\circ}\text{C} \leq T_A \leq +70^{\circ}\text{C}$, $4.5\text{V} \leq V_{CC} \leq 6.3\text{V}$ unless otherwise noted

Parameter	Conditions	Min	Max	Units
Standard Operating Voltage (V_{CC})	(Note 1)	4.5	6.3	V
Power Supply Ripple	Peak to Peak		0.5	V
Operating Supply Current	All Inputs and Outputs Open		6	mA
Input Voltage Levels				
CKI Input Levels				
Ceramic Resonator Input ($\div 8$)				
Logic High (V_{IH})	$V_{CC} = \text{Max}$	3.0		V
Logic High (V_{IH})	$V_{CC} = 5V \pm 5\%$	2.0		V
Logic Low (V_{IL})		-0.3	0.4	V
Schmitt Trigger Input ($\div 4$)				
Logic High (V_{IH})		$0.7 V_{CC}$		V
Logic Low (V_{IL})		-0.3	0.6	V
RESET Input Levels	(Schmitt Trigger Input)			
Logic High		$0.7 V_{CC}$		V
Logic Low		-0.3	0.6	V
SO Input Level (Test Mode)	(Note 2)	2.0	2.5	V
All Other Inputs				
Logic High	$V_{CC} = \text{Max}$	3.0		V
Logic High	With TTL Trip Level Options	2.0		V
Logic Low	Selected, $V_{CC} = 5V \pm 5\%$	-0.3	0.8	V
Logic High	With High Trip Level Options	3.6		V
Logic Low	Selected	-0.3	1.2	V
Input Capacitance			7	pF
Hi-Z Input Leakage		-1	+1	μA
Output Voltage Levels				
LSTTL Operation	$V_{CC} = 5V \pm 10\%$			
Logic High (V_{OH})	$I_{OH} = -25 \mu\text{A}$	2.7		V
Logic Low (V_{OL})	$I_{OL} = 0.36 \text{ mA}$		0.4	V
CMOS Operation (Note 3)				
Logic High	$I_{OH} = -10 \mu\text{A}$	$V_{CC} - 1$		V
Logic Low	$I_{OL} = +10 \mu\text{A}$		0.2	V

Note 1: V_{CC} voltage change must be less than 0.5V in a 1 ms period to maintain proper operation.

Note 2: SO output "0" level must be less than 0.8V for normal operation.

Note 3: TRI-STATE® and LED configurations are excluded.

COP410L/COP411L**DC Electrical Characteristics** $0^{\circ}\text{C} \leq T_A \leq +70^{\circ}\text{C}$, $4.5\text{V} \leq V_{\text{CC}} \leq 6.3\text{V}$ unless otherwise noted (Continued)

Parameter	Conditions	Min	Max	Units
Output Current Levels				
Output Sink Current				
SO and SK Outputs (I_{OL})	$V_{\text{CC}} = 6.3\text{V}$, $V_{\text{OL}} = 0.4\text{V}$	1.2		mA
	$V_{\text{CC}} = 4.5\text{V}$, $V_{\text{OL}} = 0.4\text{V}$	0.9		mA
L_0 - L_7 Outputs, G_0 - G_3 and LSTTL D_0 - D_3 Outputs (I_{OL})	$V_{\text{CC}} = 6.3\text{V}$, $V_{\text{OL}} = 0.4\text{V}$	0.4		mA
	$V_{\text{CC}} = 4.5\text{V}$, $V_{\text{OL}} = 0.4\text{V}$	0.4		mA
D_0 - D_3 Outputs with High Current Options (I_{OL})	$V_{\text{CC}} = 6.3\text{V}$, $V_{\text{OL}} = 1.0\text{V}$	11		mA
	$V_{\text{CC}} = 4.5\text{V}$, $V_{\text{OL}} = 1.0\text{V}$	7.5		mA
D_0 - D_3 Outputs with Very High Current Options (I_{OL})	$V_{\text{CC}} = 6.3\text{V}$, $V_{\text{OL}} = 1.0\text{V}$	22		mA
	$V_{\text{CC}} = 4.5\text{V}$, $V_{\text{OL}} = 1.0\text{V}$	15		mA
CKI (Single-Pin RC Oscillator)	$V_{\text{CC}} = 4.5\text{V}$, $V_{\text{IH}} = 3.5\text{V}$	2		mA
CKO	$V_{\text{CC}} = 4.5\text{V}$, $V_{\text{OL}} = 0.4\text{V}$	0.2		mA
Output Source Current				
Standard Configuration, All Outputs (I_{OH})	$V_{\text{CC}} = 6.3\text{V}$, $V_{\text{OH}} = 2.0\text{V}$	-75	-480	μA
	$V_{\text{CC}} = 4.5\text{V}$, $V_{\text{OH}} = 2.0\text{V}$	-30	-250	μA
Push-Pull Configuration SO and SK Outputs (I_{OH})	$V_{\text{CC}} = 6.3\text{V}$, $V_{\text{OH}} = 2.4\text{V}$	-1.4		mA
	$V_{\text{CC}} = 4.5\text{V}$, $V_{\text{OH}} = 1.0\text{V}$	-1.2		mA
LED Configuration, L_0 - L_7 Outputs, Low Current Driver Option (I_{OH})	$V_{\text{CC}} = 6.0\text{V}$, $V_{\text{OH}} = 2.0\text{V}$	-1.5	-13	mA
LED Configuration, L_0 - L_7 Outputs, High Current Driver Option (I_{OH})	$V_{\text{CC}} = 6.0\text{V}$, $V_{\text{OH}} = 2.0\text{V}$	-3.0	-25	mA
TRI-STATE Configuration, L_0 - L_7 Outputs, Low Current Driver Option (I_{OH})	$V_{\text{CC}} = 6.3\text{V}$, $V_{\text{OH}} = 3.2\text{V}$	-0.8		mA
	$V_{\text{CC}} = 4.5\text{V}$, $V_{\text{OH}} = 1.5\text{V}$	-0.9		mA
TRI-STATE Configuration, L_0 - L_7 Outputs, High Current Driver Option (I_{OH})	$V_{\text{CC}} = 6.3\text{V}$, $V_{\text{OH}} = 3.2\text{V}$	-1.6		mA
	$V_{\text{CC}} = 4.5\text{V}$, $V_{\text{OH}} = 1.5\text{V}$	-1.8		mA
Input Load Source Current	$V_{\text{CC}} = 5.0\text{V}$, $V_{\text{IL}} = 0\text{V}$	-10	-140	μA
CKO Output				
RAM Power Supply Option Power Requirement	$V_R = 3.3\text{V}$		1.5	mA
TRI-STATE Output Leakage Current		-2.5	+2.5	μA
Total Sink Current Allowed				
All Outputs Combined			100	mA
D Port			100	mA
L_7 - L_4 , G Port			4	mA
L_3 - L_0			4	mA
Any Other Pin			2.0	mA
Total Source Current Allowed				
All I/O Combined			120	mA
L_7 - L_4			60	mA
L_3 - L_0			60	mA
Each L Pin			25	mA
Any Other Pin			1.5	mA

COP310L/COP311L

Absolute Maximum Ratings

If Military/Aerospace specified devices are required, please contact the National Semiconductor Sales Office/Distributors for availability and specifications.

Voltage at Any Pin Relative to GND	-0.5V to +10V
Ambient Operating Temperature	-40°C to +85°C
Ambient Storage Temperature	-65°C to +150°C
Lead Temperature (Soldering, 10 seconds)	300°C

Power Dissipation	
COP310L	0.75W at 25°C 0.25W at 85°C
COP311L	0.65W at 25°C 0.20W at 85°C

Total Source Current	120 mA
Total Sink Current	100 mA

Note: Absolute maximum ratings indicate limits beyond which damage to the device may occur. DC and AC electrical specifications are not ensured when operating the device at absolute maximum ratings.

DC Electrical Characteristics -40°C ≤ T_A ≤ +85°C, 4.5V ≤ V_{CC} ≤ 5.5V unless otherwise noted

Parameter	Conditions	Min	Max	Units
Standard Operating Voltage (V _{CC})	(Note 1)	4.5	5.5	V
Power Supply Ripple	Peak to Peak		0.5	V
Operating Supply Current	All Inputs and Outputs Open		8	mA
Input Voltage Levels				
Ceramic Resonator Input (÷8)				
Crystal Input				
Logic High (V _{IH})	V _{CC} = Max	3.0		V
Logic High (V _{IH})	V _{CC} = 5V ±5%	2.2		V
Logic Low (V _{IL})		-0.3	0.3	V
Schmitt Trigger Input (÷4)				
Logic High (V _{IH})		0.7 V _{CC}		V
Logic Low (V _{IL})		-0.3	0.4	V
RESET Input Levels				
(Schmitt Trigger Input)				
Logic High		0.7 V _{CC}		V
Logic Low		-0.3	0.4	V
SO Input Level (Test Mode)	(Note 2)	2.2	2.5	V
All Other Inputs				
Logic High	V _{CC} = Max	3.0		V
Logic High	With TTL Trip Level Options	2.2		V
Logic Low	Selected, V _{CC} = 5V ±5%	-0.3	0.6	V
Logic High	With High Trip Level Options	3.6		V
Logic Low	Selected	-0.3	1.2	V
Input Capacitance			7	pF
Hi-Z Input Leakage		-2	+2	μA
Output Voltage Levels				
LSTTL Operation				
Logic High (V _{OH})	V _{CC} = 5V ±10% I _{OH} = -20 μA	2.7		V
Logic Low (V _{OL})	I _{OL} = 0.36 mA		0.4	V
CMOS Operation (Note 3)				
Logic High	I _{OH} = -10 μA	V _{CC} - 1		V
Logic Low	I _{OL} = +10 μA		0.2	V

Note 1: V_{CC} voltage change must be less than 0.5V in a 1 ms period to maintain proper operation.

Note 2: SO output "0" level must be less than 0.6V for normal operation.

Note 3: TRI-STATE and LED configurations are excluded.

COP310L/COP311L

DC Electrical Characteristics (Continued)

-40°C ≤ T_A ≤ +85°C, 4.5V ≤ V_{CC} ≤ 5.5V unless otherwise noted

Parameter	Conditions	Min	Max	Units
Output Current Levels				
Output Sink Current				
SO and SK Outputs (I _{OL})	V _{CC} = 5.5V, V _{OL} = 0.4V	1.0		mA
	V _{CC} = 4.5V, V _{OL} = 0.4V	0.8		mA
L ₀ -L ₇ Outputs, G ₀ -G ₃ and LSTTL D ₀ -D ₃ Outputs (I _{OL})	V _{CC} = 5.5V, V _{OL} = 0.4V	0.4		mA
	V _{CC} = 4.5V, V _{OL} = 0.4V	0.4		mA
D ₀ -D ₃ Outputs with High Current Options (I _{OL})	V _{CC} = 5.5V, V _{OL} = 1.0V	9		mA
	V _{CC} = 4.5V, V _{OL} = 1.0V	7		mA
D ₀ -D ₃ Outputs with Very High Current Options (I _{OL})	V _{CC} = 5.5V, V _{OL} = 1.0V	18		mA
	V _{CC} = 4.5V, V _{OL} = 1.0V	14		mA
CKI (Single-Pin RC Oscillator)	V _{CC} = 4.5V, V _{IH} = 3.5V	1.5		mA
CKO	V _{CC} = 4.5V, V _{OL} = 0.4V	0.2		mA
Output Source Current				
Standard Configuration, All Outputs (I _{OH})	V _{CC} = 5.5V, V _{OH} = 2.0V	-55	-600	μA
	V _{CC} = 4.5V, V _{OH} = 2.0V	-28	-350	μA
Push-Pull Configuration SO and SK Outputs (I _{OH})	V _{CC} = 5.5V, V _{OH} = 2.0V	-1.1		mA
	V _{CC} = 4.5V, V _{OH} = 1.0V	-1.2		mA
LED Configuration, L ₀ -L ₇ Outputs, Low Current Driver Option (I _{OH})	V _{CC} = 5.5V, V _{OH} = 2.0V	-0.7	-15	μA
LED Configuration, L ₀ -L ₇ Outputs, High Current Driver Option (I _{OH})	V _{CC} = 5.5V, V _{OH} = 2.0V	-1.4	-30	μA
TRI-STATE Configuration, L ₀ -L ₇ Outputs, Low Current Driver Option (I _{OH})	V _{CC} = 5.5V, V _{OH} = 2.7V	-0.6		mA
	V _{CC} = 4.5V, V _{OH} = 1.5V	-0.9		mA
TRI-STATE Configuration, L ₀ -L ₇ Outputs, High Current Driver Option (I _{OH})	V _{CC} = 5.5V, V _{OH} = 2.7V	-1.2		mA
	V _{CC} = 4.5V, V _{OH} = 1.5V	-1.8		mA
Input Load Source Current	V _{CC} = 5.0V, V _{IL} = 0V	-10	-200	μA
CKO Output RAM Power Supply Option Power Requirement	V _R = 3.3V		2.0	mA
TRI-STATE Output Leakage Current		-5	+5	μA
Total Sink Current Allowed				
All Outputs Combined			100	mA
D Port			100	mA
L ₇ -L ₄ , G Port			4	mA
L ₃ -L ₀			4	mA
Any Other Pins			1.5	mA
Total Source Current Allowed				
All I/O Combined			120	mA
L ₇ -L ₄			60	mA
L ₃ -L ₀			60	mA
Each L Pin			25	mA
Any Other Pins			1.5	mA

AC Electrical Characteristics

COP410L/411L: $0^{\circ}\text{C} \leq T_A \leq 70^{\circ}\text{C}$, $4.5\text{V} \leq V_{CC} \leq 6.3\text{V}$ unless otherwise noted
 COP310L/311L: $-40^{\circ}\text{C} \leq T_A \leq +85^{\circ}\text{C}$, $4.5\text{V} \leq V_{CC} \leq 5.5\text{V}$ unless otherwise noted

Parameter	Conditions	Min	Max	Units
Instruction Cycle Time — t_C		16	40	μs
CKI				
Input Frequency — f_I	$\div 8$ Mode	0.2	0.5	MHz
	$\div 4$ Mode	0.1	0.25	MHz
Duty Cycle		30	60	%
Rise Time	$f_I = 0.5\text{MHz}$		500	ns
Fall Time			200	ns
CKI Using RC ($\div 4$) (Note 1)	$R = 56\text{k}\Omega \pm 5\%$ $C = 100\text{pF} \pm 10\%$			
Instruction Cycle Time		16	28	μs
CKO as SYNC Input t_{SYNC}		400		ns
INPUTS				
G_3-G_0, L_7-L_0				
t_{SETUP}		8.0		μs
t_{HOLD}		1.3		μs
SI				
t_{SETUP}		2.0		μs
t_{HOLD}		1.0		μs
OUTPUT PROPAGATION DELAY				
	Test Condition: $C_L = 50\text{pF}, R_L = 20\text{k}\Omega, V_{\text{OUT}} = 1.5\text{V}$			
SO, SK Outputs $t_{\text{pd1}}, t_{\text{pd0}}$			4.0	μs
All Other Outputs $t_{\text{pd1}}, t_{\text{pd0}}$			5.6	μs

Note 1: Variation due to the device included.

Connection Diagrams

SO Wide and DIP

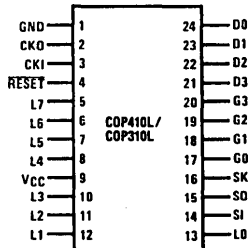

Top View

TL/DD/6919-2

SO Wide and DIP

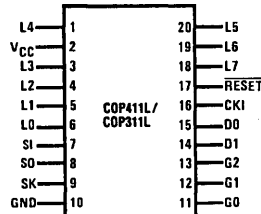

Top View

TL/DD/6919-3

Order Number COP310L-XXX/D or COP410L-XXX/D
 See NS Hermetic Package Number D24C

Order Number COP310L-XXX/N or COP410L-XXX/N
 See NS Molded Package Number N24A

Order Number COP311L-XXX/D or COP411L-XXX/D
 See NS Hermetic Package Number D24C

Order Number COP311L-XXX/N or COP411L-XXX/N
 See NS Molded Package Number N20A

FIGURE 2

Pin Descriptions

Pin	Description
L_7-L_0	8 bidirectional I/O ports with TRI-STATE
G_3-G_0	4 bidirectional I/O ports (G_2-G_0 for COP411L)
D_3-D_0	4 general purpose outputs (D_1-D_0 for COP411L)
SI	Serial input (or counter input)
SO	Serial output (or general purpose output)
SK	Logic-controlled clock (or general purpose output)

Pin	Description
CKI	System oscillator input
CKO	System oscillator output (or RAM power supply or SYNC input) (COP410L only)
RESET	System reset input
V_{CC}	Power supply
GND	Ground

Timing Diagrams

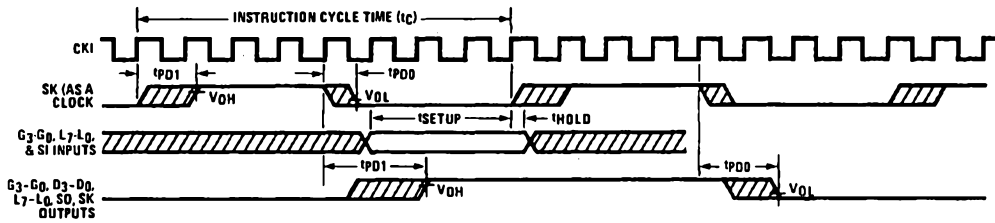

FIGURE 3. Input/Output Timing Diagrams (Ceramic Resonator Divide-by-8 Mode)

TL/DD/6919-4

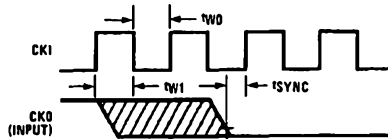

FIGURE 3a. Synchronization Timing

TL/DD/6919-5

Functional Description

A block diagram of the COP410L is given in *Figure 1*. Data paths are illustrated in simplified form to depict how the various logic elements communicate with each other in implementing the instruction set of the device. Positive logic is used. When a bit is set, it is a logic "1" (greater than 2V). When a bit is reset, it is a logic "0" (less than 0.8V).

All functional references to the COP410L/COP411L also apply to the COP310L/COP311L.

PROGRAM MEMORY

Program Memory consists of a 512-byte ROM. As can be seen by an examination of the COP410L/411L instruction set, these words may be program instructions, program data or ROM addressing data. Because of the special characteristics associated with the JP, JSRP, JID and LQID instructions, ROM must often be thought of as being organized into 8 pages of 64 words each.

ROM addressing is accomplished by a 9-bit PC register. Its binary value selects one of the 512 8-bit words contained in ROM. A new address is loaded into the PC register during each instruction cycle. Unless the instruction is a transfer of control instruction, the PC register is loaded with the next sequential 9-bit binary count value. Two levels of subroutine nesting are implemented by the 9-bit subroutine save registers, SA and SB, providing a last-in, first-out (LIFO) hardware subroutine stack.

ROM instruction words are fetched, decoded and executed by the Instruction Decode, Control and Skip Logic circuitry.

DATA MEMORY

Data memory consists of a 128-bit RAM, organized as 4 data registers of 8 4-bit digits. RAM addressing is implemented by a 6-bit B register whose upper 2 bits (Br) select 1 of 4 data registers and lower 3 bits of the 4-bit Bd select 1 of 8 4-bit digits in the selected data register. While the 4-bit contents of the selected RAM digit (M) is usually loaded into or from, or exchanged with, the A register (accumulator), it

may also be loaded into the Q latches or loaded from the L ports. RAM addressing may also be performed directly by the XAD 3,15 instruction. The Bd register also serves as a source register for 4-bit data sent directly to the D outputs.

The most significant bit of Bd is not used to select a RAM digit. Hence each physical digit of RAM may be selected by two different values of Bd as shown in *Figure 4* below. The skip condition for XIS and XDS instructions will be true if Bd changes between 0 and 15, but NOT between 7 and 8 (see Table III).

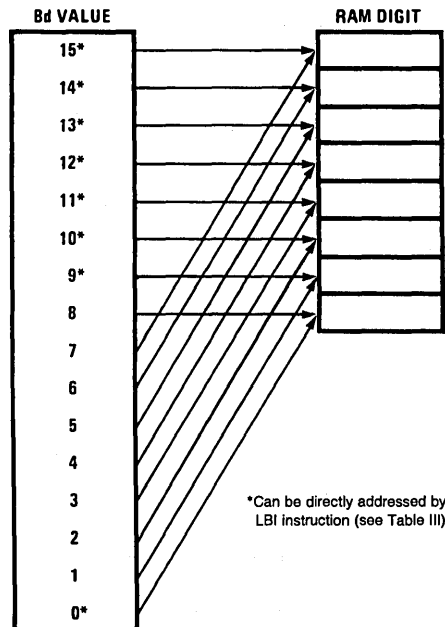

*Can be directly addressed by LBI instruction (see Table III)

FIGURE 4. RAM Digit Address to Physical RAM Digit Mapping

TL/DD/6919-6

Functional Description (Continued)

INTERNAL LOGIC

The 4-bit A register (accumulator) is the source and destination register for most I/O, arithmetic, logic and data memory access operations. It can also be used to load the Bd portion of the B register, to load 4 bits of the 8-bit Q latch data, to input 4 bits of the 8-bit L I/O port data and to perform data exchanges with the SIO register.

A 4-bit adder performs the arithmetic and logic functions of the COP410L/411L, storing its results in A. It also outputs a carry bit to the 1-bit C register, most often employed to indicate arithmetic overflow. The C register, in conjunction with the XAS instruction and the EN register, also serves to control the SK output. C can be outputted directly to SK or can enable SK to be a sync clock each instruction cycle time. (See XAS instruction and EN register description, below.)

The G register contents are outputs to 4 general-purpose bidirectional I/O ports.

The Q register is an internal, latched, 8-bit register, used to hold data loaded from M and A, as well as 8-bit data from ROM. Its contents are output to the L I/O ports when the L drivers are enabled under program control. (See LEI instruction.)

The 8 L drivers, when enabled, output the contents of latched Q data to the L I/O ports. Also, the contents of L may be read directly into A and M. L I/O ports can be directly connected to the segments of a multiplexed LED display (using the LED Direct Drive output configuration option) with Q data being outputted to the Sa-Sg and decimal point segments of the display.

The SIO register functions as a 4-bit serial-in serial-out shift register or as a binary counter depending on the contents of the EN register. (See EN register description, below.) Its contents can be exchanged with A, allowing it to input or output a continuous serial data stream. SIO may also be used to provide additional parallel I/O by connecting SO to external serial-in/parallel-out shift registers.

The XAS instruction copies C into the SKL Latch. In the counter mode, SK is the output of SKL in the shift register mode, SK outputs SKL ANDed with internal instruction cycle clock.

The EN register is an internal 4-bit register loaded under program control by the LEI instruction. The state of each bit of this register selects or deselects the particular feature associated with each bit of the EN register (EN₃-EN₀).

1. The least significant bit of the enable register, EN₀, selects the SIO register as either a 4-bit shift register or a 4-bit binary counter. With EN₀ set, SIO is an asynchronous binary counter, *decrementing* its value by one upon

each low-going pulse ("1" to "0") occurring on the SI input. Each pulse must be at least two instruction cycles wide. SK outputs the value of SKL. The SO output is equal to the value of EN₃. With EN₀ reset, SIO is a serial shift register shifting left each instruction cycle time. The data present at SI goes into the least significant bit of SIO. SO can be enabled to output the most significant bit of SIO each cycle time. (See 4 below.) The SK output becomes a logic-controlled clock.

- EN₁ is not used. It has no effect on COP410L/COP411L operation.
- With EN₂ set, the L drivers are enabled to output the data in Q to the L I/O ports. Resetting EN₂ disables the L drivers, placing the L I/O ports in a high-impedance input state.
- EN₃, in conjunction with EN₀, affects the SO output. With EN₀ set (binary counter option selected) SO will output the value loaded into EN₃. With EN₀ reset (serial shift register option selected), setting EN₃ enables SO as the output of the SIO shift register, outputting serial shifted data each instruction time. Resetting EN₃ with the serial shift register option selected disables SO as the shift register output; data continues to be shifted through SIO and can be exchanged with A via an XAS instruction but SO remains reset to "0." Table I provides a summary of the modes associated with EN₃ and EN₀.

INITIALIZATION

The Reset Logic will initialize (clear) the device upon power-up if the power supply rise time is less than 1 ms and greater than 1 μ s. If the power supply rise time is greater than 1 ms, the user must provide an external RC network and diode to the $\overline{\text{RESET}}$ pin as shown below (Figure 5). The $\overline{\text{RESET}}$ pin is configured as a Schmitt trigger input. If not used it should be connected to V_{CC}. Initialization will occur whenever a logic "0" is applied to the $\overline{\text{RESET}}$ input, provided it stays low for at least three instruction cycle times.

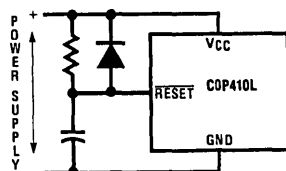

$$RC \geq 5 \times \text{Power Supply Rise Time} \quad \text{TL/DD/6919-7}$$

FIGURE 5. Power-Up Clear Circuit

TABLE I. Enable Register Modes—Bits EN₃ and EN₀

EN ₃	EN ₀	SIO	SI	SO	SK
0	0	Shift Register	Input to Shift Register	0	If SKL = 1, SK = Clock If SKL = 0, SK = 0
1	0	Shift Register	Input to Shift Register	Serial Out	If SKL = 1, SK = Clock If SKL = 0, SK = 0
0	1	Binary Counter	Input to Binary Counter	0	If SKL = 1, SK = 1 If SKL = 0, SK = 0
1	1	Binary Counter	Input to Binary Counter	1	If SKL = 1, SK = 1 If SKL = 0, SK = 0

Functional Description (Continued)

Upon initialization, the PC register is cleared to 0 (ROM address 0) and the A, B, C, D, EN, and G registers are cleared. The SK output is enabled as a SYNC output, providing a pulse each instruction cycle time. *Data Memory (RAM) is not cleared upon initialization.* The first instruction at address 0 must be a CLRA.

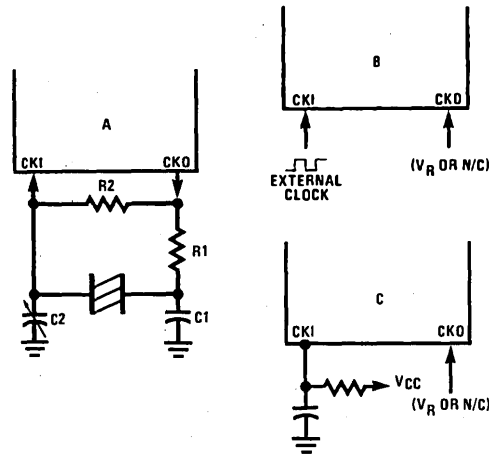

TL/DD/6919-8

Ceramic Resonator Oscillator

Resonator Value	Components Values			
	R1 (Ω)	R2 (Ω)	C1 (pF)	C2 (pF)
455 kHz	4.7k	1M	220	220

RC Controlled Oscillator

R (k Ω)	C (pF)	Instruction Cycle Time In μ s
51	100	19 \pm 15%
82	56	19 \pm 13%

Note: 200 k Ω \geq R \geq 25 k Ω . 360 pF \geq C \geq 50 pF. Does not include tolerances.

FIGURE 6. COP410L/411L Oscillator

OSCILLATOR

There are three basic clock oscillator configurations available as shown by Figure 6.

- Resonator Controlled Oscillator.** CKI and CKO are connected to an external ceramic resonator. The instruction cycle frequency equals the resonator frequency divided by 8. This is not available in the COP411L.
 - External Oscillator.** CKI is an external clock input signal. The external frequency is divided by 4 to give the instruction frequency time. CKO is now available to be used as the RAM power supply (V_R), or no connection.
- Note: No CKO on COP411L.
- RC Controlled Oscillator.** CKI is configured as a single pin RC controlled Schmitt trigger oscillator. The instruction cycle equals the oscillation frequency divided by 4. CKO is available as the RAM power supply (V_R) or no connection.

CKO PIN OPTIONS

In a resonator controlled oscillator system, CKO is used as an output to the resonator network. As an option, CKO can be a RAM power supply pin (V_R), allowing its connection to a standby/backup power supply to maintain the integrity of RAM data with minimum power drain when the main supply is inoperative or shut down to conserve power. Using no connection option is appropriate in applications where the COP410L system timing configuration does not require use of the CKO pin.

RAM KEEP-ALIVE OPTION

Selecting CKO as the RAM power supply (V_R) allows the user to shut off the chip power supply (V_{CC}) and maintain data in the RAM. To insure that RAM data integrity is maintained, the following conditions must be met:

- $\overline{\text{RESET}}$ must go low before V_{CC} goes below spec during power-off; V_{CC} must be within spec before $\overline{\text{RESET}}$ goes high on power-up.
- During normal operation, V_R must be within the operating range of the chip with $(V_{CC} - 1) \leq V_R \leq V_{CC}$.
- V_R must be $\geq 3.3V$ with V_{CC} off.

I/O OPTIONS

COP410L/411L inputs and outputs have the following optional configurations, illustrated in Figure 7:

- Standard**—an enhancement-mode device to ground in conjunction with a depletion-mode device to V_{CC} , compatible with LSTTL and CMOS input requirements. Available on SO, SK, and all D and G outputs.
 - Open-Drain**—an enhancement-mode device to ground only, allowing external pull-up as required by the user's application. Available on SO, SK, and all D and G outputs.
 - Push-Pull**—an enhancement-mode device to ground in conjunction with a depletion-mode device paralleled by an enhancement-mode device to V_{CC} . This configuration has been provided to allow for fast rise and fall times when driving capacitive loads. Available on SO and SK outputs only.
 - Standard L**—same as a., but may be disabled. Available on L outputs only.
 - Open Drain L**—same as b., but may be disabled. Available on L outputs only.
 - LED Direct Drive**—an enhancement mode device to ground and to V_{CC} , meeting the typical current sourcing requirements of the segments of an LED display. The sourcing device is clamped to limit current flow. These devices may be turned off under program control (see Functional Description, EN Register), placing the outputs in a high-impedance state to provide required LED segment blanking for a multiplexed display. Available on L outputs only.
- Note: Series current limiting resistors must be used if LEDs are driven directly and higher operating voltage option is selected.
- TRI-STATE Push-Pull**—an enhancement-mode device to ground and V_{CC} . These outputs are TRI-STATE outputs, allowing for connection of these outputs to a data bus shared by other bus drivers. Available on L outputs only.

Functional Description (Continued)

h. An on-chip depletion load device to V_{CC} .

i. A Hi-Z input which must be driven to a "1" or "0" by external components.

The above input and output configurations share common enhancement-mode and depletion-mode devices. Specifically, all configurations use one or more of six devices (numbered 1–6, respectively). Minimum and maximum current (I_{OUT} and V_{OUT}) curves are given in *Figure 8* for each of these devices to allow the designer to effectively use these I/O configurations in designing a COP410L/411L system.

The SO, SK outputs can be configured as shown in a., b., or c. The D and G outputs can be configured as shown in a. or b. Note that when inputting data to the G ports, the G outputs should be set to "1". The L outputs can be configured as in d., e., f., or g.

An important point to remember if using configuration d. or f. with the L drivers is that even when the L drivers are disabled, the depletion load device will source a small amount of current. (See *Figure 8*, device 2.) However, when the L port is used as input, the disabled depletion device CANNOT be relied on to source sufficient current to pull an input to a logic "1".

COP411L

If the COP410L is bonded as a 20-pin device, it becomes the COP411L, illustrated in *Figure 2*, COP410L/411L Connection Diagrams. Note that the COP411L does not contain D2, D3, G3, or CKO. Use of this option of course precludes use of D2, D3, G3, and CKO options. All other options are available for the COP411L.

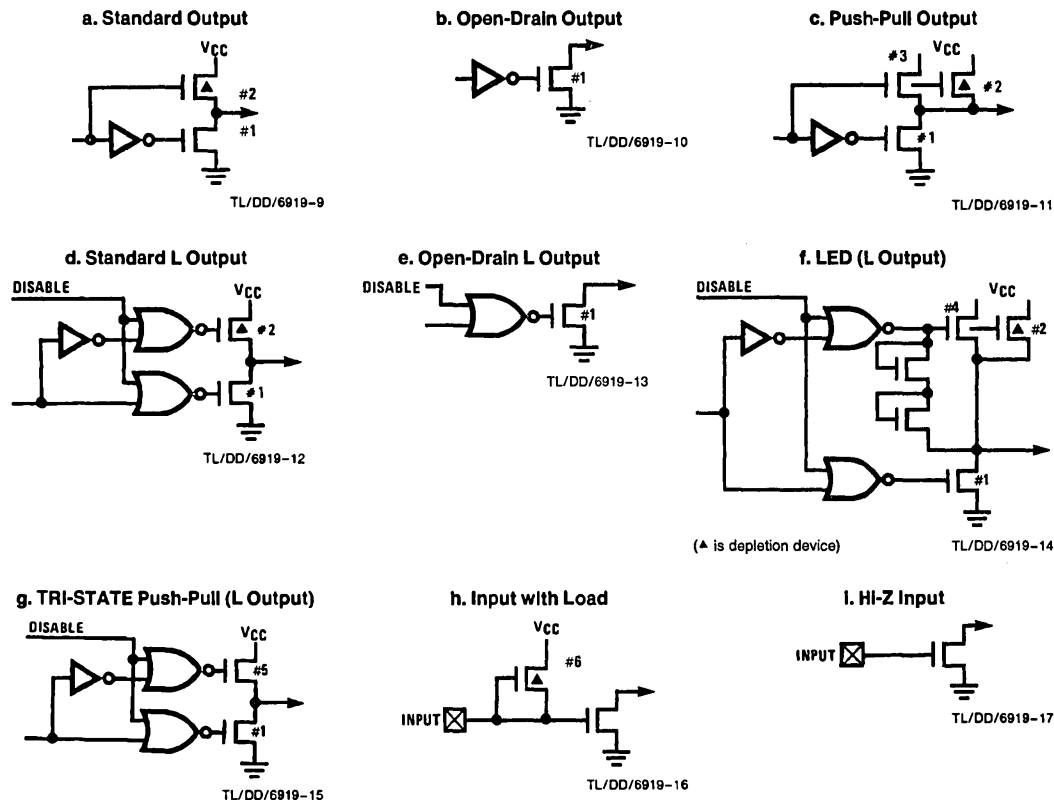

FIGURE 7. Input and Output Configurations

Typical Performance Characteristics

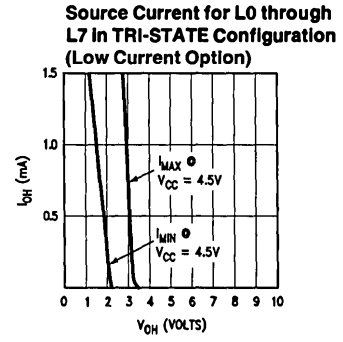
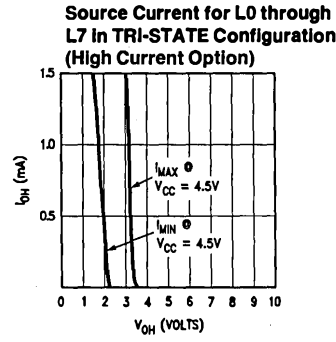
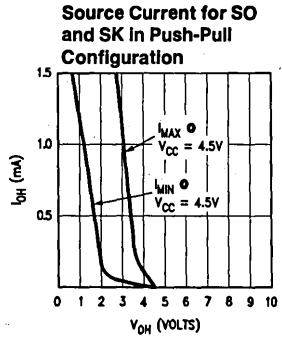
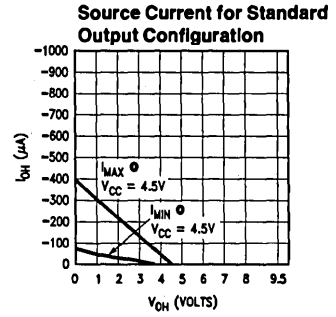
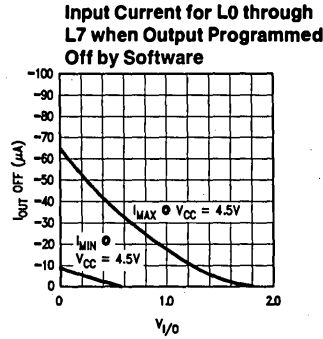
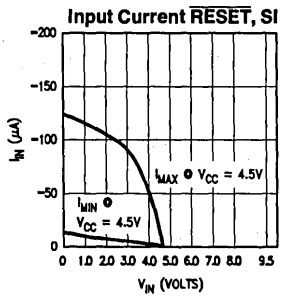

FIGURE 8a. COP410L/COP411L I/O DC Current Characteristics

TL/DD/6918-18

Typical Performance Characteristics (Continued)

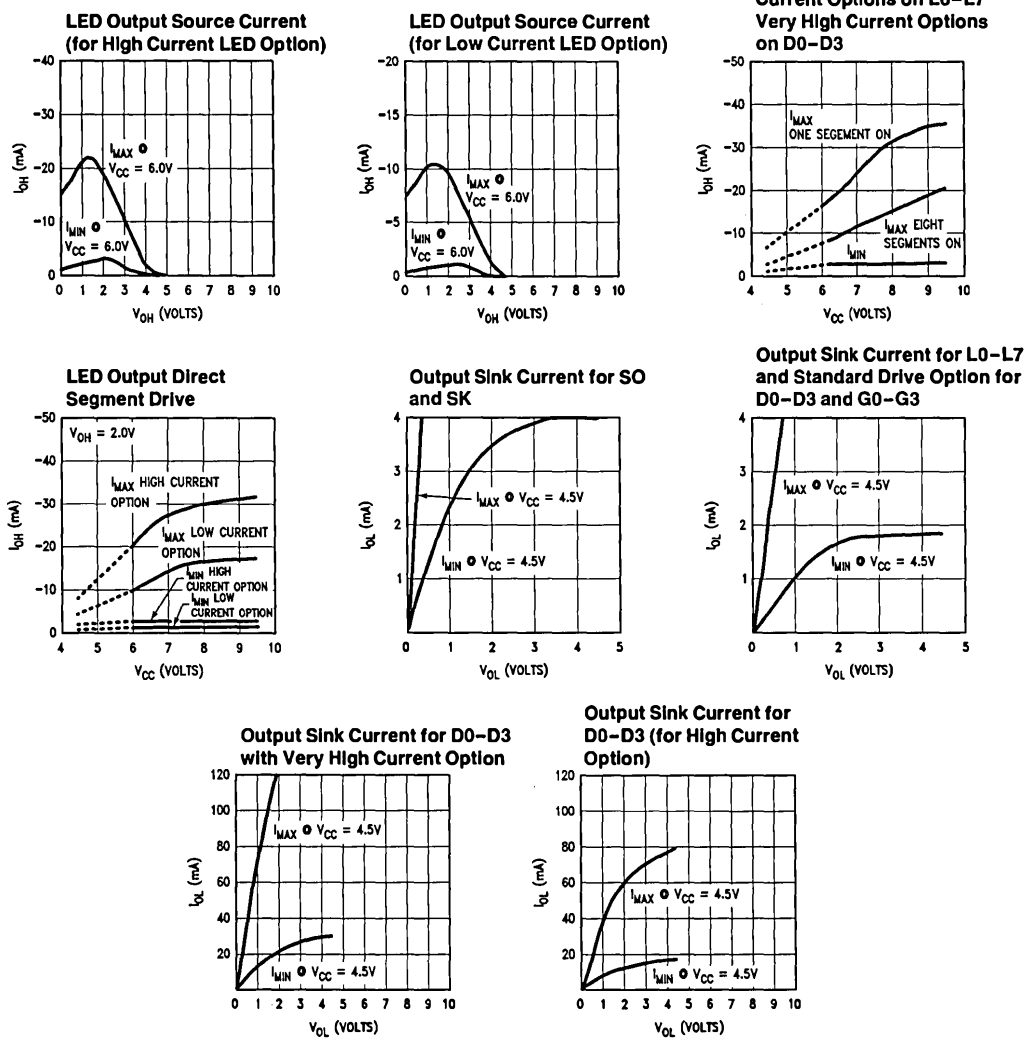

FIGURE 8a. COP410L/COP411L I/O DC Current Characteristics (Continued)

TL/DD/6919-19

Typical Performance Characteristics (Continued)

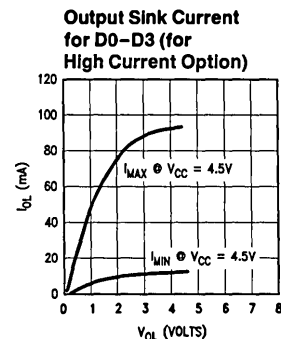
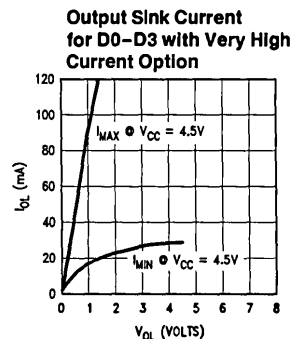
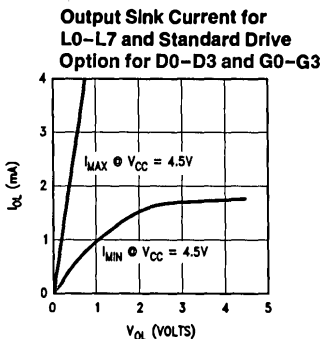
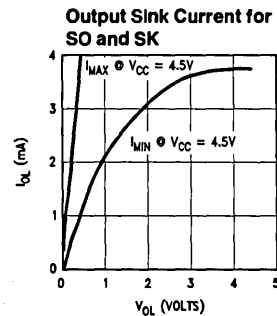
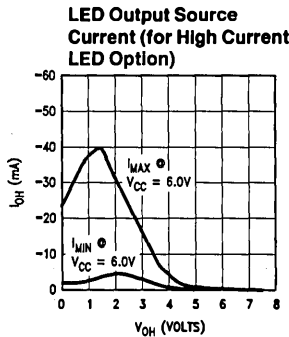
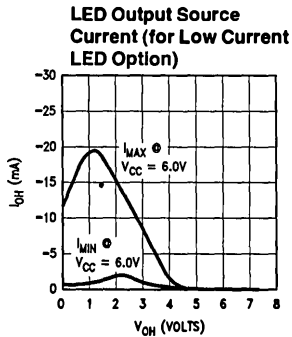
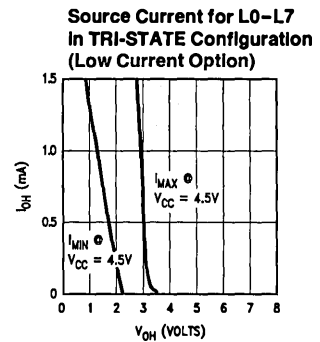
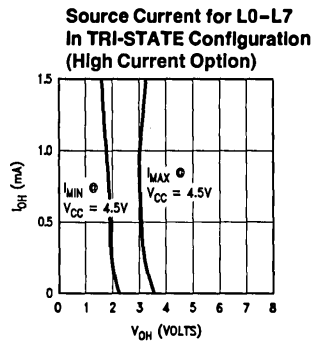
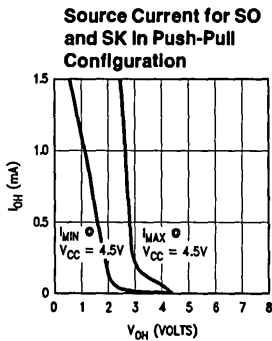
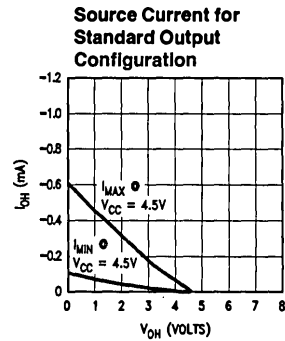
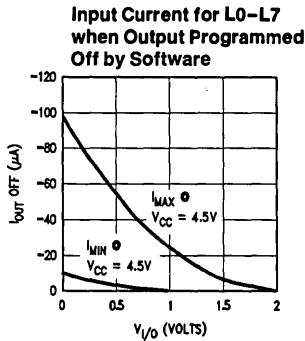
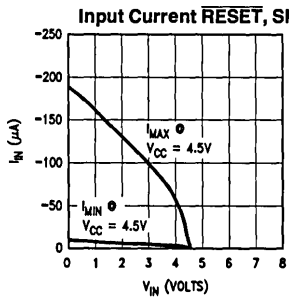
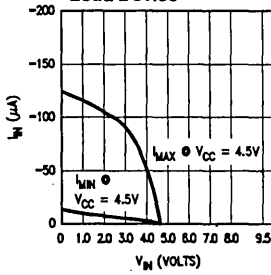

FIGURE 8b. COP310L/COP311L Input/Output Characteristics

TL/DD/6919-20

Typical Performance Characteristics

Current for Inputs with Load Device



Input Current for L₀ through L₇ when Output Programmed Off by Software

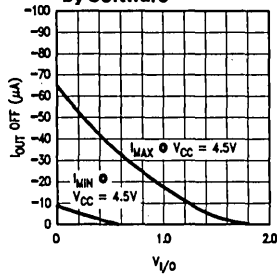

Source Current for Standard Output Configuration

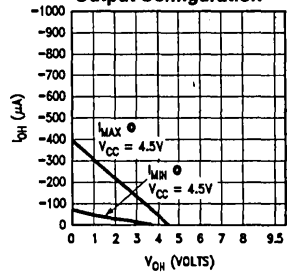

Source Current for SO and SK In Push-Pull Configuration

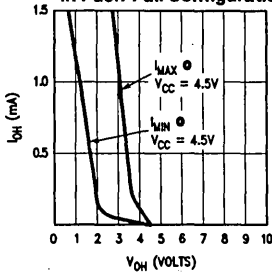

Source Current for L₀ through L₇ in TRI-STATE Configuration (High Current Option)

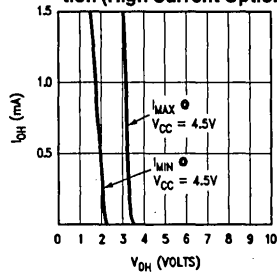

Source Current for L₀ through L₇ in TRI-STATE configuration (Low Current Option)

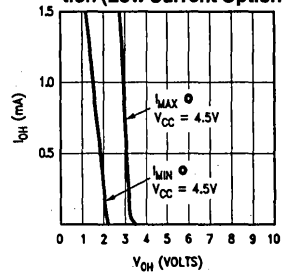

TL/DD/6919-18

Typical Performance Characteristics (Continued)

LED Output Source Current (for High Current LED Option)

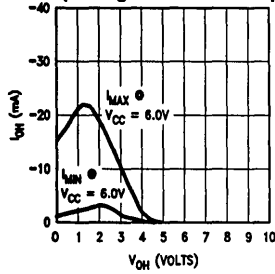

LED Output Source Current (for Low Current LED Option)

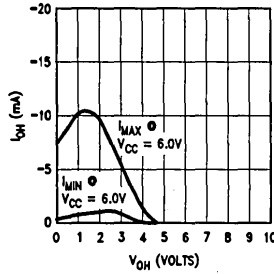

LED Output Direct Segment Drive High Current Options on L₀-L₇ Very High Current Options on D₀-D₃ or G₀-G₃

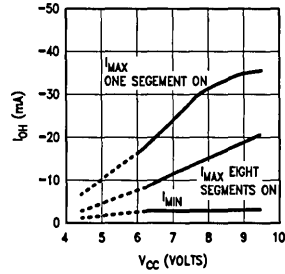

LED Output Direct Segment Drive

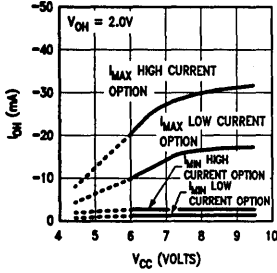

Output Sink Current for SO and SK

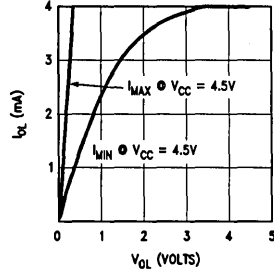

Output Sink Current for L₀-L₇ and Standard Drive Option for D₀-D₃ and G₀-G₃

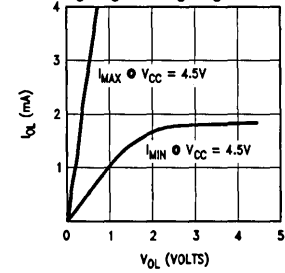

Output Sink Current G₀-G₃ and D₀-D₃ with Very High Current Option

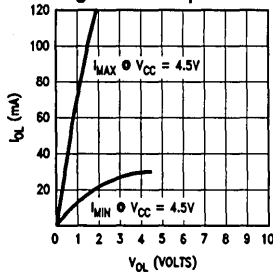

Output Sink Current for G₀-G₃ and D₀-D₃ (for High Current Option)

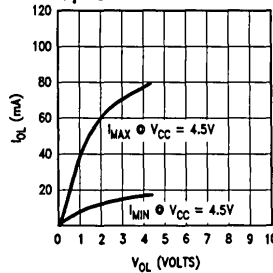

FIGURE 8a. COP410L/COP411L Input/Output Characteristics

TL/DD/6919-19

Typical Performance Characteristics (Continued)

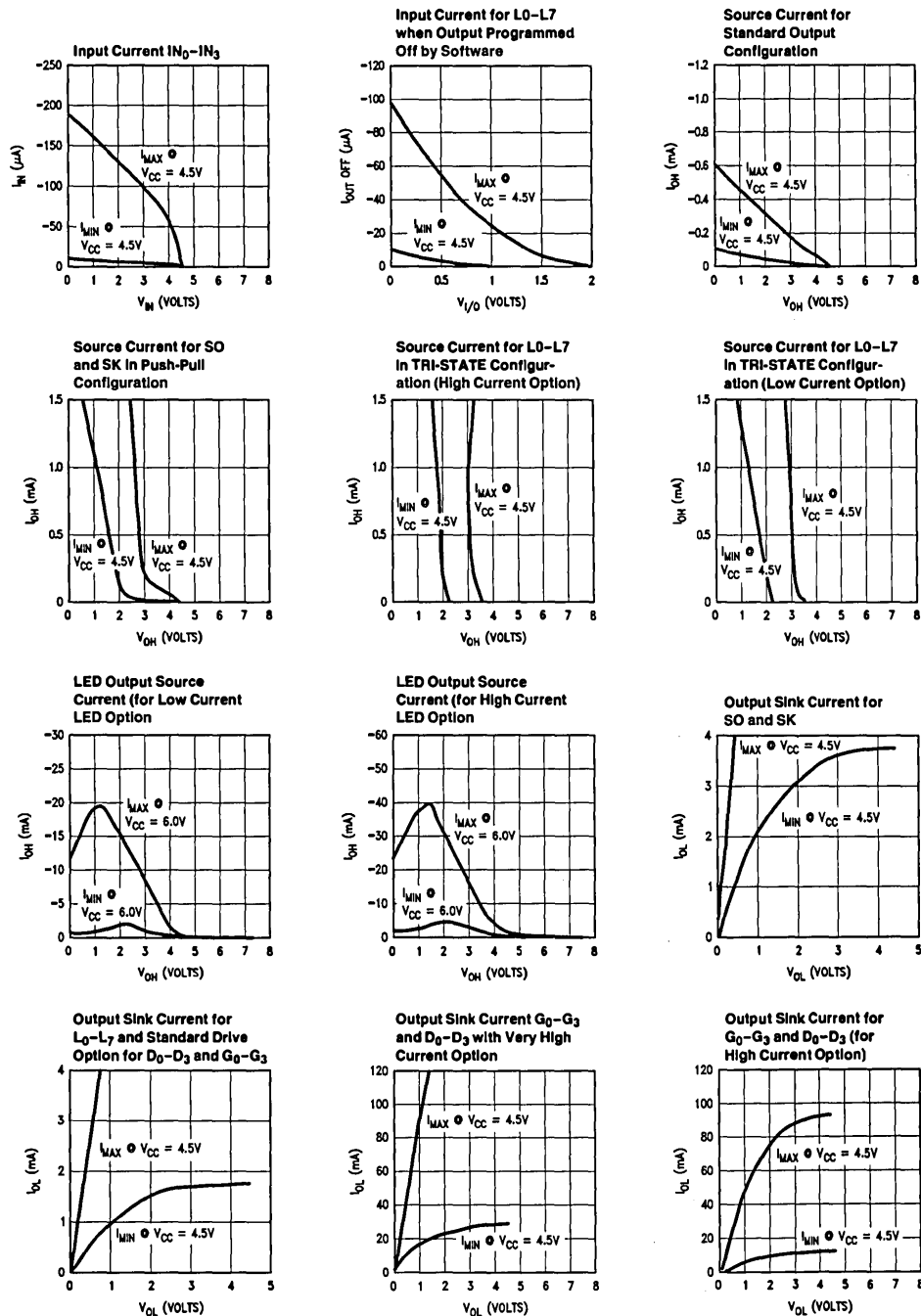

FIGURE 8b. COP310L/COP311L Input/Output Characteristics

TL/DD/6919-20

COP410L/411L Instruction Set

Table II is a symbol table providing internal architecture, instruction operand and operational symbols used in the instruction set table.

Table III provides the mnemonic, operand, machine code, data flow, skip conditions and description associated with each instruction in the COP410L/411L instruction set.

TABLE II. COP410L/411L Instruction Set Table Symbols

Symbol	Definition	Symbol	Definition
INTERNAL ARCHITECTURE SYMBOLS		INSTRUCTION OPERAND SYMBOLS	
A	4-bit Accumulator	d	4-bit Operand Field, 0-15 binary (RAM Digit Select)
B	6-bit RAM Address Register	r	2-bit Operand Field, 0-3 binary (RAM Register Select)
Br	Upper 2 bits of B (register address)	a	9-bit Operand Field, 0-511 binary (ROM Address)
Bd	Lower 4 bits of B (digit address)	y	4-bit Operand Field, 0-15 binary (Immediate Data)
C	1-bit Carry Register	RAM(s)	Contents of RAM location addressed by s
D	4-bit Data Output Port	ROM(t)	Contents of ROM location addressed by t
EN	4-bit Enable Register		
G	4-bit Register to latch data for G I/O Port		
L	8-bit TRI-STATE I/O Port		
M	4-bit contents of RAM Memory pointed to by B Register		
PC	9-bit ROM Address Register (program counter)		
Q	8-bit Register to latch data for L I/O Port		
SA	9-bit Subroutine Save Register A		
SB	9-bit Subroutine Save Register B		
SIO	4-bit Shift Register and Counter		
SK	Logic-Controlled Clock Output		
		OPERATIONAL SYMBOLS	
		+	Plus
		-	Minus
		→	Replaces
		↔	Is exchanged with
		=	Is equal to
		\bar{A}	The one's complement of A
		⊕	Exclusive-OR
		:	Range of values

TABLE III. COP410L/411L Instruction Set

Mnemonic	Operand	Hex Code	Machine Language Code (Binary)	Data Flow	Skip Conditions	Description
ARITHMETIC INSTRUCTIONS						
ASC		30	[0011 0000]	$A + C + RAM(B) \rightarrow A$ $Carry \rightarrow C$	Carry	Add with Carry, Skip on Carry
ADD		31	[0011 0001]	$A + RAM(B) \rightarrow A$	None	Add RAM to A
AISC	y	5-	[0101 y]	$A + y \rightarrow A$	Carry	Add Immediate, Skip on Carry ($y \neq 0$)
CLRA		00	[0000 0000]	$0 \rightarrow A$	None	Clear A
COMP		40	[0100 0000]	$\bar{A} \rightarrow A$	None	One's complement of A to A
NOP		44	[0100 0100]	None	None	No Operation
RC		32	[0011 0010]	"0" $\rightarrow C$	None	Reset C
SC		22	[0010 0010]	"1" $\rightarrow C$	None	Set C
XOR		02	[0000 0010]	$A \oplus RAM(B) \rightarrow A$	None	Exclusive-OR RAM with A

Instruction Set (Continued)

TABLE III. COP410L/411L Instruction Set (Continued)

Mnemonic	Operand	Hex Code	Machine Language Code (Binary)	Data Flow	Skip Conditions	Description
TRANSFER OF CONTROL INSTRUCTIONS						
JID		FF	<u>1111</u> <u>1111</u>	ROM (PC _{8,A,M}) → PC _{7:0}	None	Jump Indirect (Note 2)
JMP	a	6-- --	<u>0110</u> <u>000</u> <u>a₈</u> <u>a_{7:0}</u>	a → PC	None	Jump
JP	a	-- --	<u>1</u> <u>a_{6:0}</u> (pages 2,3 only) or <u>11</u> <u>a_{5:0}</u> (all other pages)	a → PC _{6:0} a → PC _{5:0}	None	Jump within Page (Note 3)
JSRP	a	--	<u>10</u> <u>a_{5:0}</u>	PC + 1 → SA → SB 010 → PC _{8:6} a → PC _{5:0}	None	Jump to Subroutine Page (Note 4)
JSR	a	6-- --	<u>0110</u> <u>100</u> <u>a₈</u> <u>a_{7:0}</u>	PC + 1 → SA → SB a → PC	None	Jump to Subroutine
RET		48	<u>0100</u> <u>1000</u>	SB → SA → PC	None	Return from Subroutine
RETSK		49	<u>0100</u> <u>1001</u>	SB → SA → PC	Always Skip on Return	Return from Subroutine then Skip
MEMORY REFERENCE INSTRUCTIONS						
CAMQ		33 3C	<u>0011</u> <u>0011</u> <u>0011</u> <u>1100</u>	A → Q _{7:4} RAM(B) → Q _{3:0}	None	Copy A, RAM to Q
LD	r	-5	<u>00</u> <u>r</u> <u>0101</u>	RAM(B) → A Br ⊕ r → Br	None	Load RAM into A, Exclusive-OR Br with r
LQID		BF	<u>1011</u> <u>1111</u>	ROM(PC _{8,A,M}) → Q SA → SB	None	Load Q Indirect (Note 2)
RMB	0 1 2 3	4C 45 42 43	<u>0100</u> <u>1100</u> <u>0100</u> <u>0101</u> <u>0100</u> <u>0010</u> <u>0100</u> <u>0011</u>	0 → RAM(B) ₀ 0 → RAM(B) ₁ 0 → RAM(B) ₂ 0 → RAM(B) ₃	None	Reset RAM Bit
SMB	0 1 2 3	4D 47 46 4B	<u>0100</u> <u>1101</u> <u>0100</u> <u>0111</u> <u>0100</u> <u>0110</u> <u>0100</u> <u>1011</u>	1 → RAM(B) ₀ 1 → RAM(B) ₁ 1 → RAM(B) ₂ 1 → RAM(B) ₃	None	Set RAM Bit
STII	y	7--	<u>0111</u> <u>y</u>	y → RAM(B) Bd + 1 → Bd	None	Store Memory Immediate and Increment Bd
X	r	-6	<u>00</u> <u>r</u> <u>0110</u>	RAM(B) ↔ A Br ⊕ r → Br	None	Exchange RAM with A, Exclusive-OR Br with r
XAD	3,15	23 BF	<u>0010</u> <u>0011</u> <u>1011</u> <u>1111</u>	RAM(3,15) ↔ A	None	Exchange A with RAM (3,15)
XDS	r	-7	<u>00</u> <u>r</u> <u>0111</u>	RAM(B) ↔ A Bd - 1 → Bd Br ⊕ r → Br	Bd decrements past 0	Exchange RAM with A and Decrement Bd, Exclusive-OR Br with r
XIS	r	-4	<u>00</u> <u>r</u> <u>0100</u>	RAM(B) ↔ A Bd + 1 → Bd Br ⊕ r → Br	Bd increments past 15	Exchange RAM with A and Increment Bd Exclusive-OR Br with r

Instruction Set (Continued)

TABLE III. COP410L/411L Instruction Set (Continued)

Mnemonic	Operand	Hex Code	Machine Language Code (Binary)	Data Flow	Skip Conditions	Description
REGISTER REFERENCE INSTRUCTIONS						
CAB		50	[0101 0000]	A → Bd	None	Copy A to Bd
CBA		4E	[0100 1110]	Bd → A	None	Copy Bd to A
LBI	r,d	--	[00 r (d-1)] (d = 0,9:15)	r,d → B	Skip until not a LBI	Load B Immediate with r,d (Note 5)
LEI	y	33 6-	[0011 0011] [0110 y]	y → EN	None	Load EN Immediate (Note 6)
TEST INSTRUCTIONS						
SKC		20	[0010 0000]		C = "1"	Skip if C is True
SKE		21	[0010 0001]		A = RAM(B)	Skip if A Equals RAM
SKGZ		33 21	[0011 0011] [0010 0001]		G _{3:0} = 0	Skip if G is Zero (all 4 bits)
SKGBZ	0 1 2 3	33 01 11 03 13	[0011 0011] [0000 0001] [0001 0001] [0000 0011] [0001 0011]	1st byte 2nd byte	G ₀ = 0 G ₁ = 0 G ₂ = 0 G ₃ = 0	Skip if G Bit is Zero
SKMBZ	0 1 2 3	01 11 03 13	[0000 0001] [0001 0001] [0000 0011] [0001 0011]		RAM(B) ₀ = 0 RAM(B) ₁ = 0 RAM(B) ₂ = 0 RAM(B) ₃ = 0	Skip if RAM Bit is Zero
INPUT/OUTPUT INSTRUCTIONS						
ING		33 2A	[0011 0011] [0010 1010]	G → A	None	Input G Ports to A
INL		33 2E	[0011 0011] [0010 1110]	L _{7:4} → RAM(B) L _{3:0} → A	None	Input L Ports to RAM, A
OBD		33 3E	[0011 0011] [0011 1110]	Bd → D	None	Output Bd to D Outputs
OMG		33 3A	[0011 0011] [0011 1010]	RAM(B) → G	None	Output RAM to G Ports
XAS		4F	[0100 1111]	A ↔ SIO, C → SKL	None	Exchange A with SIO (Note 2)

Note 1: All subscripts for alphabetical symbols indicate bit numbers unless explicitly defined (e.g., Br and Bd are explicitly defined). Bits are numbered 0 to N where 0 signifies the least significant bit (low-order, right-most bit). For example, A₃ indicates the most significant (left-most) bit of the 4-bit A register.

Note 2: For additional information on the operation of the XAS, JID, and LQID instructions, see below.

Note 3: The JP instruction allows a jump, while in subroutine pages 2 or 3, to any ROM location within the two-page boundary of pages 2 or 3. The JP instruction, otherwise, permits a jump to a ROM location within the current 64-word page. JP may not jump to the last word of a page.

Note 4: A JSRP transfers program control to subroutine page 2 (0010 is loaded into the upper 4 bits of P). A JSRP may not be used when in pages 2 or 3. JSRP may not jump to the last word in page 2.

Note 5: The machine code for the lower 4 bits of the LBI instruction equals the binary value of the "d" data *minus 1*, e.g., to load the lower four bits of B (Bd) with the value 9 (1001₂), the lower 4 bits of the LBI instruction equal 8 (1000₂). To load 0, the lower 4 bits of the LBI instruction should equal 15 (1111₂).

Note 6: Machine code for operand field y for LEI instruction should equal the binary value to be latched into EN, where a "1" or "0" in each bit of EN corresponds with the selection or deselection of a particular function associated with each bit. (See Functional Description, EN Register.)

Description of Selected Instructions

The following information is provided to assist the user in understanding the operation of several unique instructions and to provide notes useful to programmers in writing COP410L/411L programs.

XAS INSTRUCTION

XAS (Exchange A with SIO) exchanges the 4-bit contents of the accumulator with the 4-bit contents of the SIO register. The contents of SIO will contain serial-in/serial-out shift register or binary counter data, depending on the value of the EN register. An XAS instruction will also affect the SK output. (See Functional Description, EN Register, above.) If SIO is selected as a shift register, an XAS instruction must be performed once every 4 instruction cycles to effect a continuous data stream.

JID INSTRUCTION

JID (Jump Indirect) is an indirect addressing instruction, transferring program control to a new ROM location pointed to indirectly by A and M. It loads the lower 8 bits of the ROM address register PC with the *contents* of ROM addressed by the 9-bit word, PC₈, A, M. PC₈ is not affected by this instruction.

Note that JID requires 2 instruction cycles to execute.

LQID INSTRUCTION

LQID (Load Q Indirect) loads the 8-bit Q register with the contents of ROM pointed to by the 9-bit word PC₈, A, M. LQID can be used for table lookup or code conversion such as BCD to seven-segment. The LQID instruction "pushes" the stack (PC + 1 → SA → SB) and replaces the least significant 8 bits of PC as follows: A → PC_{7:4}, RAM(B) → PC_{3:0}, leaving PC₈ unchanged. The ROM data pointed to by the new address is fetched and loaded into the Q latches. Next, the stack is "popped" (SB → SA → PC), restoring the saved value of PC to continue sequential program execution. Since LQID pushes SA → SB, the previous contents of SB are lost. Also, when LQID pops the stack, the previously pushed contents of SA are left in SB. The net result is that the contents of SA are placed in SB (SA → SB). Note that LQID takes two instruction cycle times to execute.

INSTRUCTION SET NOTES

- The first word of a COP410L/411L program (ROM address 0) must be a CLRA (Clear A) instruction.
- Although skipped instructions are not executed, one instruction cycle time is devoted to skipping each byte of the skipped instruction. Thus all program paths except JID and LQID take the same number of cycle times whether instructions are skipped or executed. JID and LQID instructions take 2 cycles if executed and 1 cycle if skipped.
- The ROM is organized into 8 pages of 64 words each. The Program Counter is a 9-bit binary counter, and will count through page boundaries. If a JP, JSRP, JID or LQID instruction is located in the last word of a page, the instruction operates as if it were in the next page. For example: a JP located in the last word of a page will jump to a location in the next page. Also, a LQID or JID located in the last word of page 3 or 7 will access data in the next group of 4 pages.

Option List

The COP410L/411L mask-programmable options are assigned numbers which correspond with the COP410L pins. The following is a list of COP410L options. The LED Direct Drive option on the L Lines cannot be used if higher V_{CC} option is selected. When specifying a COP411L chip, Option 2 must be set to 3, Options 20, 21, and 22 to 0. The options are programmed at the same time as the ROM pattern to provide the user with the hardware flexibility to interface to various I/O components using little or no external circuitry.

Option 1 = 0: Ground Pin — no options available

Option 2: CKO Output (no option available for COP411L)

- = 0: Clock output to ceramic resonator
- = 1: Pin is RAM power supply (V_R) input
- = 3: No connection

Option 3: CKI Input

- = 0: Oscillator input divided by 8 (500 kHz max)
- = 1: Single-pin RC controlled oscillator divided by 4
- = 2: External Schmitt trigger level clock divided by 4

Option 4: RESET input

- = 0: Load device to V_{CC}
- = 1: Hi-Z input

Option 5: L₇ Driver

- = 0: Standard output
- = 1: Open-drain output
- = 2: High current LED direct segment drive output
- = 3: High current TRI-STATE push-pull output
- = 4: Low-current LED direct segment drive output
- = 5: Low-current TRI-STATE push-pull output

Option 6: L₆ Driver

same as Option 5

Option 7: L₅ Driver

same as Option 5

Option 8: L₄ Driver

same as Option 5

Option 9: Operating voltage

- | | |
|---------------------|----------------|
| COP41XL | COP31XL |
| = 0: +4.5V to +6.3V | +4.5V to +5.5V |

Option 10: L₃ Driver

same as Option 5

Option 11: L₂ Driver

same as Option 5

Option 12: L₁ Driver

same as Option 5

Option 13: L₀ Driver

same as Option 5

Option 14: SI Input

- = 0: load device to V_{CC}
- = 1: Hi-Z input

Option 15: SO Driver

- = 0: Standard Output
- = 1: Open-drain output
- = 2: Push-pull output

Option 16: SK Driver

same as Option 15

Option List (Continued)

Option 17: G₀ I/O Port

- = 0: Standard output
- = 1: Open-drain output

Option 18: G₁ I/O Port

same as Option 17

Option 19: G₂ I/O Port

same as Option 17

Option 20: G₃ I/O Port (no option available for COP411L)

same as Option 17

Option 21: D₃ Output (no option available for COP411L)

- = 0: Very-high sink current standard output
- = 1: Very-high sink current open-drain output
- = 2: High sink current standard output
- = 3: High sink current open-drain output
- = 4: Standard LSTTL output (fanout = 1)
- = 5: Open-drain LSTTL output (fanout = 1)

Option 22: D₂ Output (no option available for COP411L)

same as Option 21

Option 23: D₁ Output

same as Option 21

Option 24: D₀ Output

same as Option 21

Option 25: L Input Levels

- = 0: Standard TTL input levels ("0" = 0.8V, "1" = 2.0V)
- = 1: Higher voltage input levels ("0" = 1.2V, "1" = 3.6V)

Option 26: G Input Levels

same as Option 25

Option 27: SI Input Levels

same as Option 25

Option 28: COP Bonding

- = 0: COP410L (24-pin device)
- = 1: COP411L (20-pin device)
- = 2: Both 24- and 20-pin versions

TEST MODE (NON-STANDARD OPERATION)

The SO output has been configured to provide for standard test procedures for the custom-programmed COP410L. With SO forced to logic "1", two test modes are provided, depending upon the value of SI:

a. RAM and Internal Logic Test Mode (SI = 1)

b. ROM Test Mode (SI = 0)

These special test modes should not be employed by the user; they are intended for manufacturing test only.

Option Table

The following option information is to be sent to National along with the EPROM.

	Option Data	
OPTION 1 VALUE =	0	IS: GROUND PIN
OPTION 2 VALUE =	_____	IS: CKO PIN
OPTION 3 VALUE =	_____	IS: CKI INPUT
OPTION 4 VALUE =	_____	IS: RESET INPUT
OPTION 5 VALUE =	_____	IS: L(7) DRIVER
OPTION 6 VALUE =	_____	IS: L(6) DRIVER
OPTION 7 VALUE =	_____	IS: L(5) DRIVER
OPTION 8 VALUE =	_____	IS: L(4) DRIVER
OPTION 9 VALUE =	0	IS: V _{CC} PIN
OPTION 10 VALUE =	_____	IS: L(3) DRIVER
OPTION 11 VALUE =	_____	IS: L(2) DRIVER
OPTION 12 VALUE =	_____	IS: L(1) DRIVER
OPTION 13 VALUE =	_____	IS: L(0) DRIVER
OPTION 14 VALUE =	_____	IS: SI INPUT

	Option Data	
OPTION 15 VALUE =	_____	IS: SO DRIVER
OPTION 16 VALUE =	_____	IS: SK DRIVER
OPTION 17 VALUE =	_____	IS: G ₀ I/O PORT
OPTION 18 VALUE =	_____	IS: G ₁ I/O PORT
OPTION 19 VALUE =	_____	IS: G ₂ I/O PORT
OPTION 20 VALUE =	_____	IS: G ₃ I/O PORT
OPTION 21 VALUE =	_____	IS: D ₃ OUTPUT
OPTION 22 VALUE =	_____	IS: D ₂ OUTPUT
OPTION 23 VALUE =	_____	IS: D ₁ OUTPUT
OPTION 24 VALUE =	_____	IS: D ₀ OUTPUT
OPTION 25 VALUE =	_____	IS: L INPUT LEVELS
OPTION 26 VALUE =	_____	IS: G INPUT LEVELS
OPTION 27 VALUE =	_____	IS: SI INPUT LEVELS
OPTION 28 VALUE =	_____	IS: COPS BONDING