

COP620C/COP622C/COP640C/COP642C/ COP820C/COP822C/COP840C/COP842C/ COP920C/COP922C/COP940C/COP942C Single-Chip microCMOS Microcontrollers

General Description

The COP820C and COP840C are members of the COPSTM microcontroller family. They are fully static parts, fabricated using double-metal silicon gate microCMOS technology. This low cost microcontroller is a complete microcomputer containing all system timing, interrupt logic, ROM, RAM, and I/O necessary to implement dedicated control functions in a variety of applications. Features include an 8-bit memory mapped architecture, MICROWIRE/PLUSTM serial I/O, a 16-bit timer/counter with capture register and a multi-sourced interrupt. Each I/O pin has software selectable options to adapt the device to the specific application. The part operates over a voltage range of 2.5 to 6.0V. High throughput is achieved with an efficient, regular instruction set operating at a 1 microsecond per instruction rate.

Features

- Low Cost 8-bit microcontroller
- Fully static CMOS
- 1 μ s instruction time (10 MHz clock)
- Low current drain (2.2 mA at 3 μ s instruction rate)
Low current static HALT mode (Typically < 1 μ A)
- Single supply operation: 2.5 to 6.0V

- 1024 bytes ROM/64 Bytes RAM—COP820C family
- 2048 bytes ROM/128 Bytes RAM—COP840C family
- 16-bit read/write timer operates in a variety of modes
 - Timer with 16-bit auto reload register
 - 16-bit external event counter
 - Timer with 16-bit capture register (selectable edge)
- Multi-source interrupt
 - Reset master clear
 - External interrupt with selectable edge
 - Timer interrupt or capture interrupt
 - Software interrupt
- 8-bit stack pointer (stack in RAM)
- Powerful instruction set, most instructions single byte
- BCD arithmetic instructions
- MICROWIRE/PLUS serial I/O
- 28 pin package (optionally 20 pin package)
- 24 input/output pins (28-pin package)
- Software selectable I/O options (TRI-STATE®, push-pull, weak pull-up)
- Schmitt trigger inputs on Port G
- Temperature ranges: 0°C to +70°C, -40°C to +85°C, -55°C to +125°C
- Form Factor emulation devices
- Fully supported by MetaLink's development systems

Block Diagram

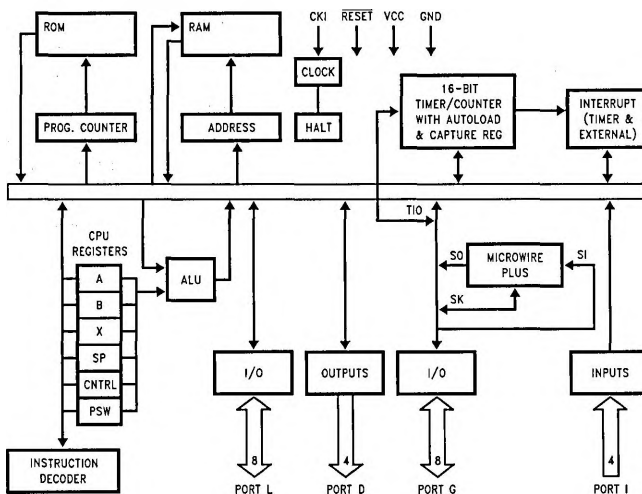

FIGURE 1

TL/DD/9103-1

COP920C/COP922C/COP940C/COP942C**Absolute Maximum Ratings**

If Military/Aerospace specified devices are required, please contact the National Semiconductor Sales Office/Distributors for availability and specifications.

Supply Voltage (V_{CC}) 7V
 Voltage at any Pin $-0.3V$ to $V_{CC} + 0.3V$
 Total Current into V_{CC} Pin (Source) 50 mA

Total Current out of GND Pin (Sink) 60 mA
 Storage Temperature Range $-65^{\circ}C$ to $+140^{\circ}C$

Note: Absolute maximum ratings indicate limits beyond which damage to the device may occur. DC and AC electrical specifications are not ensured when operating the device at absolute maximum ratings.

DC Electrical Characteristics COP92XC, COP94XC; $0^{\circ}C \leq T_A \leq +70^{\circ}C$ unless otherwise specified

Parameter	Condition	Min	Typ	Max	Units
Operating Voltage COP9XXC COP9XXCH		2.3 4.0		4.0 6.0	V V V
Power Supply Ripple (Note 1)	Peak to Peak			$0.1 V_{CC}$	V
Supply Current (Note 2) CKI = 10 MHz CKI = 4 MHz CKI = 4 MHz CKI = 1 MHz	$V_{CC} = 6V, t_c = 1 \mu s$ $V_{CC} = 6V, t_c = 2.5 \mu s$ $V_{CC} = 4V, t_c = 2.5 \mu s$ $V_{CC} = 4V, t_c = 10 \mu s$			6.0 4.0 2.0 1.2	mA mA mA mA
HALT Current (Note 3)	$V_{CC} = 6V, CKI = 0 MHz$ $V_{CC} = 4V, CKI = 0 MHz$		<0.7 <0.4	8.0 5.0	μA μA
Input Levels RESET, CKI Logic High Logic Low All Other Inputs Logic High Logic Low		$0.9 V_{CC}$ $0.7 V_{CC}$		 $0.1 V_{CC}$ $0.2 V_{CC}$	 V V V V V
Hi-Z Input Leakage Input Pullup Current	$V_{CC} = 6.0V$ $V_{CC} = 6.0V, V_{IN} = 0V$	-1 -40		+1 -250	μA μA
G Port Input Hysteresis				$0.35 V_{CC}$	V
Output Current Levels D Outputs Source Sink All Others Source (Weak Pull-Up) Source (Push-Pull Mode) Sink (Push-Pull Mode) TRI-STATE Leakage	$V_{CC} = 4.5V, V_{OH} = 3.8V$ $V_{CC} = 2.3V, V_{OH} = 1.6V$ $V_{CC} = 4.5V, V_{OL} = 1.0V$ $V_{CC} = 2.3V, V_{OL} = 0.4V$ $V_{CC} = 4.5V, V_{OH} = 3.2V$ $V_{CC} = 2.3V, V_{OH} = 1.6V$ $V_{CC} = 4.5V, V_{OH} = 3.8V$ $V_{CC} = 2.3V, V_{OH} = 1.6V$ $V_{CC} = 4.5V, V_{OL} = 0.4V$ $V_{CC} = 2.3V, V_{OL} = 0.4V$ $V_{CC} = 6.0V$	-0.4 -0.2 10 2 -10 -2.5 -0.4 -0.2 1.6 0.7 -1.0		 -110 -33 +1.0	mA mA mA mA μA μA mA mA mA μA
Allowable Sink/Source Current Per Pin D Outputs (Sink) All Others				15 3	mA mA
Maximum Input Current (Note 4) Without Latchup (Room Temp)	Room Temp			± 100	mA
RAM Retention Voltage, V_r	500 ns Rise and Fall Time (Min)	2.0			V
Input Capacitance				7	pF
Load Capacitance on D2				1000	pF

COP920C/COP922C/COP940C/COP942C**DC Electrical Characteristics** (Continued)

Note 1: Rate of voltage change must be less than 0.5V/ms.

Note 2: Supply current is measured after running 2000 cycles with a square wave CKI input, CKO open, inputs at rails and outputs open.

Note 3: The HALT mode will stop CKI from oscillating in the RC and the Crystal configurations. Test conditions: All inputs tied to V_{CC} , L and G0—G5 configured as outputs and set high. The D port set to zero.

Note 4: Except pin G7: +100 mA, -25 mA (COP920C only). Sampled and not 100% tested. Pins G6 and RESET are designed with a high voltage input network for factory testing. These pins allow input voltages greater than V_{CC} and the pins will have sink current to V_{CC} when biased at voltages greater than V_{CC} (the pins do not have source current when biased at a voltage below V_{CC}). The effective resistance to V_{CC} is 750 Ω (typical). These two pins will not latch up. The voltage at the pins must be limited to less than 14V.

AC Electrical Characteristics $0^{\circ}\text{C} \leq T_A \leq +70^{\circ}\text{C}$ unless otherwise specified

Parameter	Condition	Min	Typ	Max	Units
Instruction Cycle Time (tc) Ext., Crystal/Resonator (Div-by 10)	$V_{CC} \geq 4.0\text{V}$ $2.3\text{V} \leq V_{CC} \leq 4.0\text{V}$	1 2.5		DC DC	μs μs
R/C Oscillator Mode (Div-by 10)	$V_{CC} \geq 4.0\text{V}$ $2.3\text{V} \leq V_{CC} \leq 4.0\text{V}$	3 7.5		DC DC	μs μs
CKI Clock Duty Cycle (Note 5)	fr = Max	40		60	%
Rise Time (Note 5)	fr = 10 MHz Ext Clock			12	ns
Fall Time (Note 5)	fr = 10 MHz Ext Clock			8	ns
Inputs					
t_{SETUP}	$V_{CC} \geq 4.0\text{V}$ $2.3\text{V} \leq V_{CC} \leq 4.0\text{V}$	200 500			ns ns
t_{HOLD}	$V_{CC} \geq 4.0\text{V}$ $2.3\text{V} \leq V_{CC} \leq 4.0\text{V}$	60 150			ns ns
Output Propagation Delay t_{PD1} , t_{PD0} SO, SK	$C_L = 100\text{ pF}$, $R_L = 2.2\text{ k}\Omega$ $V_{CC} \geq 4.0\text{V}$ $2.5\text{V} \leq V_{CC} \leq 4.0\text{V}$			0.7 1.75	μs μs
All Others	$V_{CC} \geq 4.0\text{V}$ $2.5\text{V} \leq V_{CC} \leq 4.0\text{V}$			1 2.5	μs μs
MICROWIRE™ Setup Time (t_{UWS})		20			ns
MICROWIRE Hold Time (t_{UWH})		56			ns
MICROWIRE Output Propagation Delay (t_{UPD})				220	ns
Input Pulse Width					
Interrupt Input High Time		t_C			
Interrupt Input Low Time		t_C			
Timer Input High Time		t_C			
Timer Input Low Time		t_C			
Reset Pulse Width		1.0			μs

Note 5: Parameter sampled (not 100% tested).

COP820C/COP822C/COP840C/COP842C**Absolute Maximum Ratings**

If Military/Aerospace specified devices are required, please contact the National Semiconductor Sales Office/Distributors for availability and specifications.

Supply Voltage (V_{CC}) 7V
 Voltage at any Pin $-0.3V$ to $V_{CC} + 0.3V$
 Total Current into V_{CC} Pin (Source) 50 mA

Total Current out of GND Pin (Sink) 60 mA
 Storage Temperature Range -65°C to $+140^{\circ}\text{C}$

Note: Absolute maximum ratings indicate limits beyond which damage to the device may occur. DC and AC electrical specifications are not ensured when operating the device at absolute maximum ratings.

DC Electrical Characteristics COP82XC, COP84XC: $-40^{\circ}\text{C} \leq T_A \leq +85^{\circ}\text{C}$ unless otherwise specified

Parameter	Condition	Min	Typ	Max	Units
Operating Voltage		2.5		6.0	V
Power Supply Ripple (Note 1)	Peak to Peak			$0.1 V_{CC}$	V
Supply Current (Note 2)					
CKI = 10 MHz	$V_{CC} = 6V, t_c = 1 \mu\text{s}$			6.0	mA
CKI = 4 MHz	$V_{CC} = 6V, t_c = 2.5 \mu\text{s}$			4.0	mA
CKI = 4 MHz	$V_{CC} = 4.0V, t_c = 2.5 \mu\text{s}$			2.0	mA
CKI = 1 MHz	$V_{CC} = 4.0V, t_c = 10 \mu\text{s}$			1.2	mA
HALT Current (Note 3)	$V_{CC} = 6V, \text{CKI} = 0 \text{ MHz}$		<1	10	μA
Input Levels					
RESET, CKI					
Logic High		$0.9 V_{CC}$			V
Logic Low				$0.1 V_{CC}$	V
All Other Inputs					
Logic High		$0.7 V_{CC}$			V
Logic Low				$0.2 V_{CC}$	V
Hi-Z Input Leakage	$V_{CC} = 6.0V$	-2		+2	μA
Input Pullup Current	$V_{CC} = 6.0V, V_{IN} = 0V$	-40		-250	μA
G Port Input Hysteresis				$0.35 V_{CC}$	V
Output Current Levels					
D Outputs					
Source	$V_{CC} = 4.5V, V_{OH} = 3.8V$	-0.4			mA
	$V_{CC} = 2.5V, V_{OH} = 1.8V$	-0.2			mA
Sink	$V_{CC} = 4.5V, V_{OL} = 1.0V$	10			mA
	$V_{CC} = 2.5V, V_{OL} = 0.4V$	2			mA
All Others					
Source (Weak Pull-Up)	$V_{CC} = 4.5V, V_{OH} = 3.2V$	-10		-110	μA
	$V_{CC} = 2.5V, V_{OH} = 1.8V$	-2.5		-33	μA
Source (Push-Pull Mode)	$V_{CC} = 4.5V, V_{OH} = 3.8V$	-0.4			mA
	$V_{CC} = 2.5V, V_{OH} = 1.8V$	-0.2			mA
Sink (Push-Pull Mode)	$V_{CC} = 4.5V, V_{OL} = 0.4V$	1.6			mA
	$V_{CC} = 2.5V, V_{OL} = 0.4V$	0.7			mA
TRI-STATE Leakage		-2.0		+2.0	μA
Allowable Sink/Source Current Per Pin					
D Outputs (Sink)				15	mA
All Others				3	mA
Maximum Input Current (Note 4) Without Latchup (Room Temp)	Room Temp			± 100	mA
RAM Retention Voltage, Vr	500 ns Rise and Fall Time (Min)	2.0			V
Input Capacitance				7	pF
Load Capacitance on D2				1000	pF

Note 1: Rate of voltage change must be less than 0.5V/ms.

Note 2: Supply current is measured after running 2000 cycles with a square wave CKI input, CKO open, inputs at rails and outputs open.

Note 3: The HALT mode will stop CKI from oscillating in the RC and the Crystal configurations. Test conditions: All inputs tied to V_{CC} , L and G0—G5 configured as outputs and set high. The D port set to zero.

Note 4: Except pin G7: +100 mA, -25 mA (COP820C only). Sampled and not 100% tested. Pins G6 and RESET are designed with a high voltage input network for factory testing. These pins allow input voltages greater than V_{CC} and the pins will have sink current to V_{CC} when biased at voltages greater than V_{CC} (the pins do not have source current when biased at a voltage below V_{CC}). The effective resistance to V_{CC} is 750 Ω (typical). These two pins will not latch up. The voltage at the pins must be limited to less than 14V.

COP820C/COP822C/COP840C/COP842C

AC Electrical Characteristics $-40^{\circ}\text{C} \leq T_A \leq +85^{\circ}\text{C}$ unless otherwise specified

Parameter	Condition	Min	Typ	Max	Units
Instruction Cycle Time (t_c) Ext. or Crystal/Resonator (Div-by 10) R/C Oscillator Mode (Div-by 10)	$V_{CC} \geq 4.5V$	1		DC	μs
	$2.5V \leq V_{CC} < 4.5V$	2.5		DC	μs
	$V_{CC} \geq 4.5V$	3		DC	μs
	$2.5V \leq V_{CC} < 4.5V$	7.5		DC	μs
CKI Clock Duty Cycle (Note 5) Rise Time (Note 5) Fall Time (Note 5)	$f_r = \text{Max}$	40		60	%
	$f_r = 10 \text{ MHz Ext Clock}$			12	ns
	$f_r = 10 \text{ MHz Ext Clock}$			8	ns
Inputs t_{SETUP} t_{HOLD}	$V_{CC} \geq 4.5V$	200			ns
	$2.5V \leq V_{CC} < 4.5V$	500			ns
	$V_{CC} \geq 4.5V$	60			ns
	$2.5V \leq V_{CC} < 4.5V$	150			ns
Output Propagation Delay t_{PD1} , t_{PD0} SO, SK All Others	$C_L = 100 \text{ pF}, R_L = 2.2 \text{ k}\Omega$				
	$V_{CC} \geq 4.5V$			0.7	μs
	$2.5V \leq V_{CC} < 4.5V$			1.75	μs
	$V_{CC} \geq 4.5V$			1	μs
	$2.5V \leq V_{CC} < 4.5V$			2.5	μs
MICROWIRE Setup Time (t_{uws})		20			ns
MICROWIRE Hold Time (t_{uwh})		56			ns
MICROWIRE Output Propagation Delay (t_{UPD})				220	ns
Input Pulse Width Interrupt Input High Time Interrupt Input Low Time Timer Input High Time Timer Input Low Time		t_c			
		t_c			
		t_c			
		t_c			
Reset Pulse Width		1.0			μs

Note 5: Parameter sampled (not 100% tested).

Timing Diagram

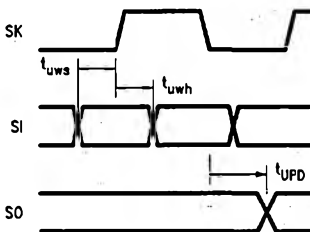

FIGURE 2. MICROWIRE/PLUS Timing

TL/DD/9103-19

COP620C/COP622C/COP640C/COP642C**Absolute Maximum Ratings**

If Military/Aerospace specified devices are required, please contact the National Semiconductor Sales Office/Distributors for availability and specifications.

Supply Voltage (V_{CC})	6V
Voltage at any Pin	-0.3V to V_{CC} + 0.3V
Total Current into V_{CC} Pin (Source)	40 mA

Total Current out of GND Pin (Sink)	48 mA
Storage Temperature Range	-65°C to +140°C

Note: Absolute maximum ratings indicate limits beyond which damage to the device may occur. DC and AC electrical specifications are not ensured when operating the device at absolute maximum ratings.

DC Electrical Characteristics COP62XC, COP64XC: $-55^{\circ}\text{C} \leq T_A \leq +125^{\circ}\text{C}$ unless otherwise specified

Parameter	Condition	Min	Typ	Max	Units
Operating Voltage		4.5		5.5	V
Power Supply Ripple (Note 1)	Peak to Peak			0.1 V_{CC}	V
Supply Current (Note 2)				6.0	mA
CKI = 10 MHz	$V_{CC} = 5.5\text{V}$, $t_c = 1 \mu\text{s}$			4	mA
CKI = 4 MHz	$V_{CC} = 5.5\text{V}$, $t_c = 2.5 \mu\text{s}$			30	μA
HALT Current (Note 3)	$V_{CC} = 5.5\text{V}$, CKI = 0 MHz		<10		μA
Input Levels					
RESET, CKI					
Logic High		0.9 V_{CC}			V
Logic Low				0.1 V_{CC}	V
All Other Inputs					
Logic High		0.7 V_{CC}			V
Logic Low				0.2 V_{CC}	V
Hi-Z Input Leakage	$V_{CC} = 5.5\text{V}$	-5		+5	μA
Input Pullup Current	$V_{CC} = 4.5\text{V}$, $V_{IN} = 0\text{V}$	-35		-300	μA
G Port Input Hysteresis				0.35 V_{CC}	V
Output Current Levels					
D Outputs					
Source	$V_{CC} = 4.5\text{V}$, $V_{OH} = 3.8\text{V}$	-0.35			mA
Sink	$V_{CC} = 4.5\text{V}$, $V_{OL} = 1.0\text{V}$	9			mA
All Others					
Source (Weak Pull-Up)	$V_{CC} = 4.5\text{V}$, $V_{OH} = 3.2\text{V}$	-9		-120	μA
Source (Push-Pull Mode)	$V_{CC} = 4.5\text{V}$, $V_{OH} = 3.6\text{V}$	-0.35			mA
Sink (Push-Pull Mode)	$V_{CC} = 4.5\text{V}$, $V_{OL} = 0.4\text{V}$	1.4			mA
TRI-STATE Leakage		-5.0		+5.0	μA
Allowable Sink/Source Current Per Pin					
D Outputs (Sink)				12	mA
All Others				2.5	mA
Maximum Input Current (Room Temp) Without Latchup (Note 5)	Room Temp			± 100	mA
RAM Retention Voltage, V_r	500 ns Rise and Fall Time (Min)	2.5			V
Input Capacitance				7	pF
Load Capacitance on D2				1000	pF

Note 1: Rate of voltage change must be less than 0.5V/ms.

Note 2: Supply current is measured after running 2000 cycles with a square wave CKI input, CKO open, inputs at rails and outputs open.

Note 3: The HALT mode will stop CKI from oscillating in the RC and the Crystal configurations. Test conditions: All inputs tied to V_{CC} , L and G0—G5 configured as outputs and set high. The D port set to zero.

Note 4: Except pin G7: +100 mA, -25 mA (COP620C only). Sampled and not 100% tested. Pins G6 and RESET are designed with a high voltage input network for factory testing. These pins allow input voltages greater than V_{CC} and the pins will have sink current to V_{CC} when biased at voltages greater than V_{CC} (the pins do not have source current when biased at a voltage below V_{CC}). The effective resistance to V_{CC} is 750 Ω (typical). These two pins will not latch up. The voltage at the pins must be limited to less than 14V.

COP620C/COP622C/COP640C/COP642C**AC Electrical Characteristics** $-55^{\circ}\text{C} \leq T_A \leq +125^{\circ}\text{C}$ unless otherwise specified

Parameter	Condition	Min	Typ	Max	Units
Instruction Cycle Time (t_c) Ext. or Crystal/Resonant (Div-by 10)	$V_{CC} \geq 4.5V$	1		DC	μs
CKI Clock Duty Cycle (Note 5)	$f_r = \text{Max}$	40		60	%
Rise Time (Note 5)	$f_r = 10 \text{ MHz Ext Clock}$			12	ns
Fall Time (Note 5)	$f_r = 10 \text{ MHz Ext Clock}$			8	ns
Inputs					
t_{SETUP}	$V_{CC} \geq 4.5V$	220			ns
t_{HOLD}	$V_{CC} \geq 4.5V$	66			ns
Output Propagation Delay	$R_L = 2.2k, C_L = 100 \text{ pF}$				
$t_{\text{PD1}}, t_{\text{PD0}}$	$V_{CC} \geq 4.5V$			0.8	μs
SO, SK	$V_{CC} \geq 4.5V$			1.1	μs
All Others	$V_{CC} \geq 4.5V$				
MICROWIRE Setup Time (t_{UWS})		20			ns
MICROWIRE Hold Time (t_{UWH})		56			ns
MICROWIRE Output Valid Time (t_{UPD})				220	ns
Input Pulse Width					
Interrupt Input High Time		t_c			
Interrupt Input Low Time		t_c			
Timer Input High Time		t_c			
Timer Input Low Time		t_c			
Reset Pulse Width		1			μs

Note 5: Parameter sampled (not 100% tested).

Typical Performance Characteristics ($-40^{\circ}\text{C} \leq T_A \leq +85^{\circ}\text{C}$)

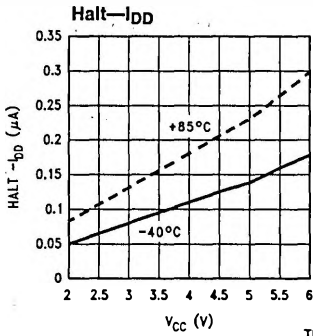

TL/DD/9103-20

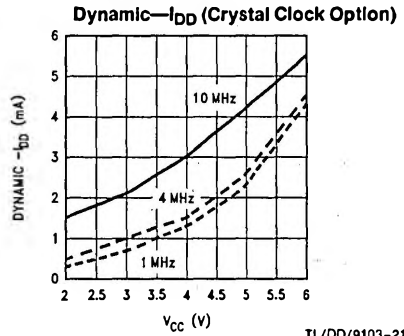

TL/DD/9103-21

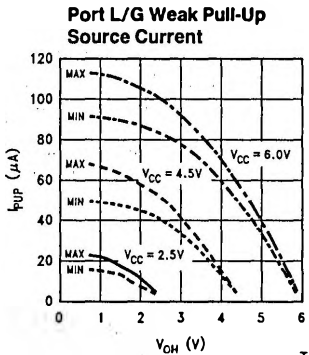

TL/DD/9103-22

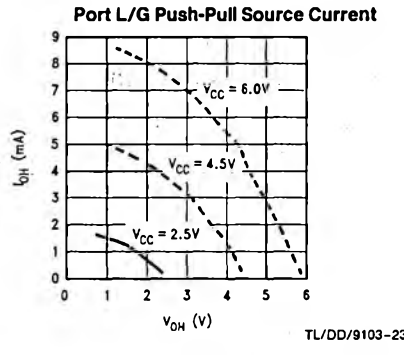

TL/DD/9103-23

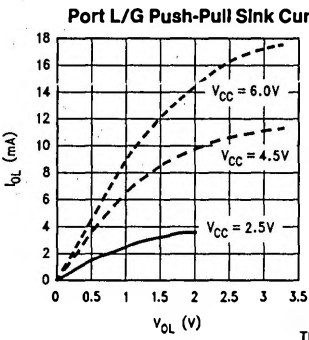

TL/DD/9103-24

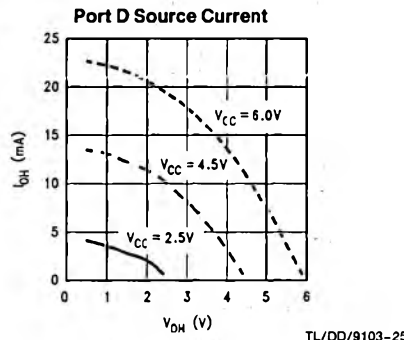

TL/DD/9103-25

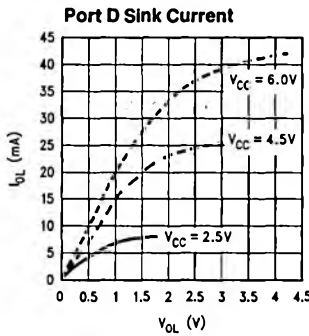

TL/DD/9103-28

Connection Diagrams

DUAL-IN-LINE PACKAGE

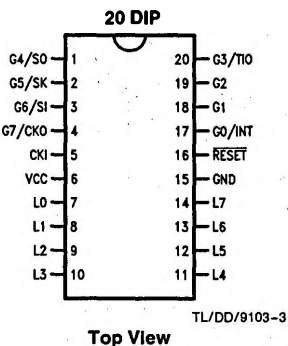

Order Number COP622C-XXX/N,
COP642C-XXX/N, COP822C-XXX/N,
COP842C-XXX/N, COP922C-XXX/N,
or COP942C-XXX/N
See NS Package Number N20A

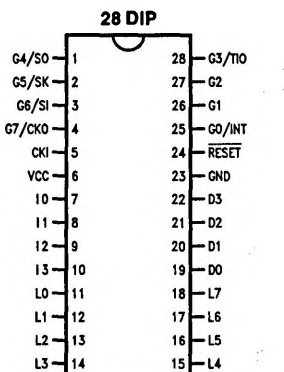

Order Number COP620C-XXX/N,
COP640C-XXX/N, COP820C-XXX/N,
COP840C-XXX/D, COP920C-XXX/N
or COP940C-XXX/N
See NS Package Number N28B

SURFACE MOUNT

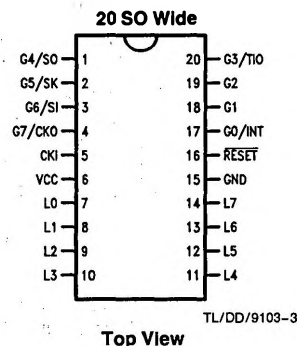

Order Number COP822C-XXX/WM,
COP842C-XXX/WM,
COP922C-XXX/WM or
COP942C-XXX/WM
See NS Package Number M20B

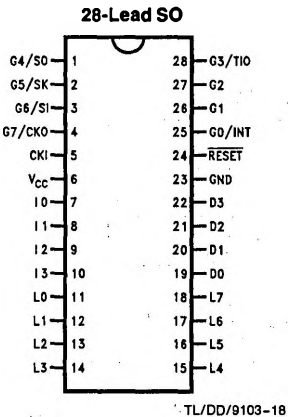

Order Number COP820C-XXX/WM,
COP840C-XXX/WM,
COP920C-XXX/WM or
COP940C-XXX/WM
See NS Package Number M28A

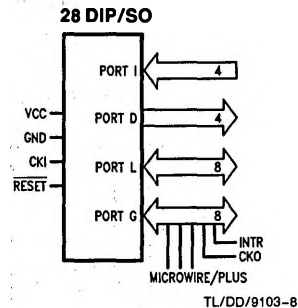
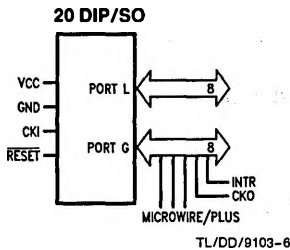

FIGURE 3. Connection Diagrams

Pin Descriptions

V_{CC} and GND are the power supply pins.

CKI is the clock input. This can come from an external source, a R/C generated oscillator or a crystal (in conjunction with CKO). See Oscillator description.

\overline{RESET} is the master reset input. See Reset description.

PORT I is a four bit Hi-Z input port.

PORT L is an 8-bit I/O port.

There are two registers associated with each L I/O port: a data register and a configuration register. Therefore, each L I/O bit can be individually configured under software control as shown below:

Port L Config.	Port L Data	Port L Setup
0	0	Hi-Z Input (TRI-STATE)
0	1	Input With Weak Pull-Up
1	0	Push-Pull "0" Output
1	1	Push-Pull "1" Output

Three data memory address locations are allocated for these ports, one for data register, one for configuration register and one for the input pins.

PORT G is an 8-bit port with 6 I/O pins (G0–G5) and 2 input pins (G6, G7). All eight G-pins have Schmitt Triggers on the inputs. The G7 pin functions as an input pin under normal operation and as the continue pin to exit the HALT mode. There are two registers with each I/O port: a data register and a configuration register. Therefore, each I/O bit can be individually configured under software control as shown below.

Port G Config.	Port G Data	Port G Setup
0	0	Hi-Z Input (TRI-STATE)
0	1	Input With Weak Pull-Up
1	0	Push-Pull "0" Output
1	1	Push-Pull "1" Output

Three data memory address locations are allocated for these ports, one for data register, one for configuration register and one for the input pins. Since G6 and G7 are input only pins, any attempt by the user to set them up as outputs by writing a one to the configuration register will be disregarded. Reading the G6 and G7 configuration bits will return zeros. Note that the chip will be placed in the HALT mode by setting the G7 data bit.

Six bits of Port G have alternate features:

- G0 INTR (an external interrupt)
- G3 TIO (timer/counter input/output)
- G4 SO (MICROWIRE serial data output)
- G5 SK (MICROWIRE clock I/O)
- G6 SI (MICROWIRE serial data input)
- G7 CKO crystal oscillator output (selected by mask option) or HALT restart input (general purpose input)

Pins G1 and G2 currently do not have any alternate functions.

PORT D is a four bit output port that is set high when \overline{RESET} goes low. Care must be exercised with the D2 pin operation. At \overline{RESET} , the external load on this pin must ensure that the output voltage stays above $0.9 V_{CC}$ to prevent the device from entering special modes. Also, keep the external loading on the D2 pin to less than 1000 pf.

Functional Description

Figure 1 shows the block diagram of the internal architecture. Data paths are illustrated in simplified form to depict how the various logic elements communicate with each other in implementing the instruction set of the device.

ALU AND CPU REGISTERS

The ALU can do an 8-bit addition, subtraction, logical or shift operation in one cycle time.

There are five CPU registers:

A is the 8-bit Accumulator register

PU is the upper 7 bits of the program counter (PC)

PL is the lower 8 bits of the program counter (PC)

B is the 8-bit address register, can be auto incremented or decremented.

X is the 8-bit alternate address register, can be incremented or decremented.

SP is the 8-bit stack pointer, points to subroutine stack (in RAM).

B, X and SP registers are mapped into the on chip RAM. The B and X registers are used to address the on chip RAM. The SP register is used to address the stack in RAM during subroutine calls and returns.

PROGRAM MEMORY

Program memory for the COP820C family consists of 1024 bytes of ROM (2048 bytes of ROM for the COP840C family). These bytes may hold program instructions or constant data. The program memory is addressed by the 15-bit program counter (PC). ROM can be indirectly read by the LAID instruction for table lookup.

DATA MEMORY

The data memory address space includes on chip RAM, I/O and registers. Data memory is addressed directly by the instruction or indirectly by the B, X and SP registers.

The COP820C family has 64 bytes of RAM and the COP840C family has 128 bytes of RAM. Sixteen bytes of RAM are mapped as "registers" that can be loaded immediately, decremented or tested. Three specific registers: B, X and SP are mapped into this space, the other bytes are available for general usage.

The instruction set permits any bit in memory to be set, reset or tested. All I/O and registers (except the A & PC) are memory mapped; therefore, I/O bits and register bits can be directly and individually set, reset and tested.

Note: RAM contents are undefined upon power-up.

RESET

The \overline{RESET} input when pulled low initializes the microcontroller. Initialization will occur whenever the \overline{RESET} input is pulled low. Upon initialization, the ports L and G are placed in the TRI-STATE mode and the Port D is set high. The PC, PSW and CNTRL registers are cleared. The data and configuration registers for Ports L & G are cleared.

The external RC network shown in Figure 4 should be used to ensure that the \overline{RESET} pin is held low until the power supply to the chip stabilizes.

Functional Description (Continued)

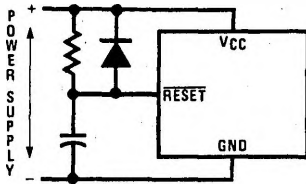

TL/DD/9103-9

$RC \geq 5X$ Power Supply Rise Time

FIGURE 4. Recommended Reset Circuit

OSCILLATOR CIRCUITS

Figure 5 shows the three clock oscillator configurations.

A. CRYSTAL OSCILLATOR

The device can be driven by a crystal clock. The crystal network is connected between the pins CKI and CKO.

Table I shows the component values required for various standard crystal values.

B. EXTERNAL OSCILLATOR

CKI can be driven by an external clock signal. CKO is available as a general purpose input and/or HALT restart control.

C. R/C OSCILLATOR

CKI is configured as a single pin RC controlled Schmitt trigger oscillator. CKO is available as a general purpose input and/or HALT restart control.

Table II shows the variation in the oscillator frequencies as functions of the component (R and C) values.

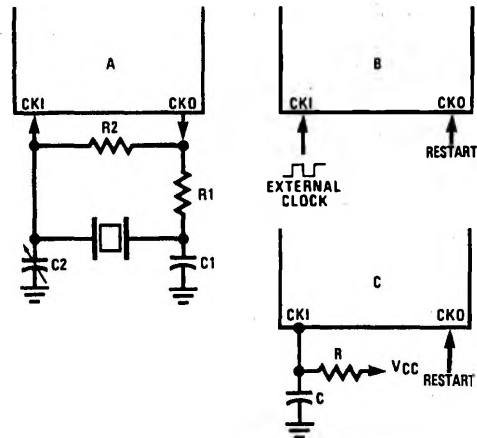

TL/DD/9103-10

FIGURE 5. Crystal and R-C Connection Diagrams

OSCILLATOR MASK OPTIONS

The device can be driven by clock inputs between DC and 10 MHz.

TABLE I. Crystal Oscillator Configuration, $T_A = 25^\circ\text{C}$

R1 (k Ω)	R2 (M Ω)	C1 (pF)	C2 (pF)	CKI Freq (MHz)	Conditions
0	1	30	30-36	10	$V_{CC} = 5V$
0	1	30	30-36	4	$V_{CC} = 5V$
0	1	200	100-150	0.455	$V_{CC} = 5V$

TABLE II. RC Oscillator Configuration, $T_A = 25^\circ\text{C}$

R (k Ω)	C (pF)	CKI Freq. (MHz)	Instr. Cycle (μs)	Conditions
3.3	82	2.2 to 2.7	3.7 to 4.6	$V_{CC} = 5V$
5.6	100	1.1 to 1.3	7.4 to 9.0	$V_{CC} = 5V$
6.8	100	0.9 to 1.1	8.8 to 10.8	$V_{CC} = 5V$

Note: $3k \leq R \leq 200k$, $50 \text{ pF} \leq C \leq 200 \text{ pF}$

Functional Description (Continued)

The device has three mask options for configuring the clock input. The CKI and CKO pins are automatically configured upon selecting a particular option.

- Crystal (CKI/10) CKO for crystal configuration
- External (CKI/10) CKO available as G7 input
- R/C (CKI/10) CKO available as G7 input

G7 can be used either as a general purpose input or as a control input to continue from the HALT mode.

CURRENT DRAIN

The total current drain of the chip depends on:

- 1) Oscillator operating mode—I1
- 2) Internal switching current—I2
- 3) Internal leakage current—I3
- 4) Output source current—I4
- 5) DC current caused by external input not at V_{CC} or GND—I5

Thus the total current drain, It is given as

$$I_t = I_1 + I_2 + I_3 + I_4 + I_5$$

To reduce the total current drain, each of the above components must be minimum.

Operating with a crystal network will draw more current than an external square-wave. The R/C mode will draw the most. Switching current, governed by the equation below, can be reduced by lowering voltage and frequency. Leakage current can be reduced by lowering voltage and temperature. The other two items can be reduced by carefully designing the end-user's system.

$$I_2 = C \times V \times f$$

Where

C = equivalent capacitance of the chip.

V = operating voltage

f = CKI frequency

HALT MODE

The device supports a power saving mode of operation: HALT. The controller is placed in the HALT mode by setting the G7 data bit, alternatively the user can stop the clock input. In the HALT mode all internal processor activities including the clock oscillator are stopped. The fully static architecture freezes the state of the controller and retains all information until continuing. In the HALT mode, power requirements are minimal as it draws only leakage currents and output current. The applied voltage (V_{CC}) may be decreased down to V_r (minimum RAM retention voltage) without altering the state of the machine.

There are two ways to exit the HALT mode: via the $\overline{\text{RESET}}$ or by the CKO pin. A low on the RESET line reinitializes the microcontroller and starts executing from the address

0000H. A low to high transition on the CKO pin (only if the external or the R/C clock option is selected) causes the microcontroller to continue with no reinitialization from the address following the HALT instruction. This also resets the G7 data bit.

INTERRUPTS

There are three interrupt sources, as shown below.

A maskable interrupt on external G0 input (positive or negative edge sensitive under software control)

A maskable interrupt on timer underflow or timer capture

A non-maskable software/error interrupt on opcode zero

INTERRUPT CONTROL

The GIE (global interrupt enable) bit enables the interrupt function. This is used in conjunction with ENI and ENTI to select one or both of the interrupt sources. This bit is reset when interrupt is acknowledged.

ENI and ENTI bits select external and timer interrupt respectively. Thus the user can select either or both sources to interrupt the microcontroller when GIE is enabled.

IEDG selects the external interrupt edge (0 = rising edge, 1 = falling edge). The user can get an interrupt on both rising and falling edges by toggling the state of IEDG bit after each interrupt.

IPND and TPND bits signal which interrupt is pending. After interrupt is acknowledged, the user can check these two bits to determine which interrupt is pending. This permits the interrupts to be prioritized under software. The pending flags have to be cleared by the user. Setting the GIE bit high inside the interrupt subroutine allows nested interrupts.

The software interrupt does not reset the GIE bit. This means that the controller can be interrupted by other interrupt sources while servicing the software interrupt.

INTERRUPT PROCESSING

The interrupt, once acknowledged, pushes the program counter (PC) onto the stack and the stack pointer (SP) is decremented twice. The Global Interrupt Enable (GIE) bit is reset to disable further interrupts. The microcontroller then vectors to the address 00FFH and resumes execution from that address. This process takes 7 cycles to complete. At the end of the interrupt subroutine, any of the following three instructions return the processor back to the main program: RET, RETSK or RETI. Either one of the three instructions will pop the stack into the program counter (PC). The stack pointer is then incremented twice. The RETI instruction additionally sets the GIE bit to re-enable further interrupts.

Any of the three instructions can be used to return from a hardware interrupt subroutine. The RETSK instruction should be used when returning from a software interrupt subroutine to avoid entering an infinite loop.

Functional Description (Continued)

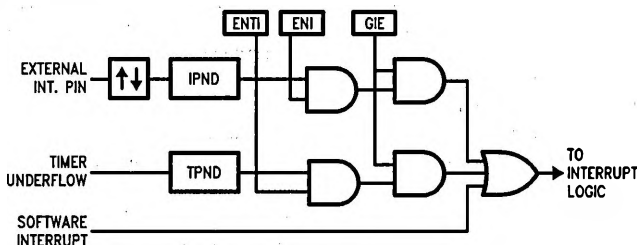

FIGURE 6. Interrupt Block Diagram

TL/DD/9103-11

DETECTION OF ILLEGAL CONDITIONS

The device contains a hardware mechanism that allows it to detect illegal conditions which may occur from coding errors, noise and 'brown out' voltage drop situations. Specifically it detects cases of executing out of undefined ROM area and unbalanced stack situations.

Reading an undefined ROM location returns 00 (hexadecimal) as its contents. The opcode for a software interrupt is also '00'. Thus a program accessing undefined ROM will cause a software interrupt.

Reading an undefined RAM location returns an FF (hexadecimal). The subroutine stack grows down for each subroutine call. By initializing the stack pointer to the top of RAM, the first unbalanced return instruction will cause the stack pointer to address undefined RAM. As a result the program will attempt to execute from FFFF (hexadecimal), which is an undefined ROM location and will trigger a software interrupt.

MICROWIRE/PLUS™

MICROWIRE/PLUS is a serial synchronous bidirectional communications interface. The MICROWIRE/PLUS capability enables the device to interface with any of National Semiconductor's MICROWIRE peripherals (i.e. A/D converters, display drivers, EEPROMS, etc.) and with other microcontrollers which support the MICROWIRE/PLUS interface. It consists of an 8-bit serial shift register (SIO) with serial data input (SI), serial data output (SO) and serial shift clock (SK). Figure 7 shows the block diagram of the MICROWIRE/PLUS interface.

The shift clock can be selected from either an internal source or an external source. Operating the MICROWIRE/PLUS interface with the internal clock source is called the Master mode of operation. Similarly, operating the MICROWIRE/PLUS interface with an external shift clock is called the Slave mode of operation.

The CNTRL register is used to configure and control the MICROWIRE/PLUS mode. To use the MICROWIRE/PLUS, the MSEL bit in the CNTRL register is set to one. The SK clock rate is selected by the two bits, SL0 and SL1, in the CNTRL register. Table III details the different clock rates that may be selected.

TABLE III

SL1	SL0	SK Cycle Time
0	0	2t _C
0	1	4t _C
1	x	8t _C

where,

t_C is the instruction cycle clock.

MICROWIRE/PLUS OPERATION

Setting the BUSY bit in the PSW register causes the MICROWIRE/PLUS arrangement to start shifting the data. It gets reset when eight data bits have been shifted. The user may reset the BUSY bit by software to allow less than 8 bits to shift. The device may enter the MICROWIRE/PLUS mode either as a Master or as a Slave. Figure 8 shows how two microcontrollers and several peripherals may be interconnected using the MICROWIRE/PLUS arrangement.

Master MICROWIRE/PLUS Operation

In the MICROWIRE/PLUS Master mode of operation the shift clock (SK) is generated internally. The MICROWIRE/PLUS Master always initiates all data exchanges. (See Figure 8). The MSEL bit in the CNTRL register must be set to enable the SO and SK functions onto the G Port. The SO and SK pins must also be selected as outputs by setting appropriate bits in the Port G configuration register. Table IV summarizes the bit settings required for Master mode of operation.

SLAVE MICROWIRE/PLUS OPERATION

In the MICROWIRE/PLUS Slave mode of operation the SK clock is generated by an external source. Setting the MSEL bit in the CNTRL register enables the SO and SK functions onto the G Port. The SK pin must be selected as an input and the SO pin is selected as an output pin by appropriately setting up the Port G configuration register. Table IV summarizes the settings required to enter the Slave mode of operation.

The user must set the BUSY flag immediately upon entering the Slave mode. This will ensure that all data bits sent by the Master will be shifted properly. After eight clock pulses the BUSY flag will be cleared and the sequence may be repeated. (See Figure 8.)

Functional Description (Continued)

TABLE IV

G4 Config. Bit	G5 Config. Bit	G4 Fun.	G5 Fun.	G6 Fun.	Operation
1	1	SO	Int. SK	SI	MICROWIRE Master
0	1	TRI-STATE	Int. SK	SI	MICROWIRE Master
1	0	SO	Ext. SK	SI	MICROWIRE Slave
0	0	TRI-STATE	Ext. SK	SI	MICROWIRE Slave

TIMER/COUNTER

The device has a powerful 16-bit timer with an associated 16-bit register enabling them to perform extensive timer functions. The timer T1 and its register R1 are each organized as two 8-bit read/write registers. Control bits in the register CNTRL allow the timer to be started and stopped under software control. The timer-register pair can be operated in one of three possible modes. Table V details various timer operating modes and their requisite control settings.

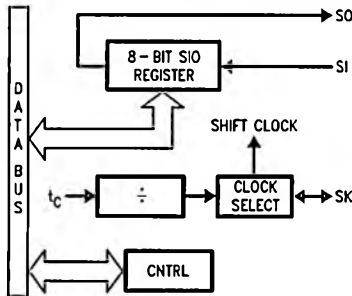

TL/DD/9103-12

FIGURE 7. MICROWIRE/PLUS Block Diagram

MODE 1. TIMER WITH AUTO-LOAD REGISTER

In this mode of operation, the timer T1 counts down at the instruction cycle rate. Upon underflow the value in the register R1 gets automatically reloaded into the timer which continues to count down. The timer underflow can be programmed to interrupt the microcontroller. A bit in the control register CNTRL enables the TIO (G3) pin to toggle upon timer underflows. This allows the generation of square-wave outputs or pulse width modulated outputs under software control. (See Figure 9)

MODE 2. EXTERNAL COUNTER

In this mode, the timer T1 becomes a 16-bit external event counter. The counter counts down upon an edge on the TIO pin. Control bits in the register CNTRL program the counter to decrement either on a positive edge or on a negative edge. Upon underflow the contents of the register R1 are automatically copied into the counter. The underflow can also be programmed to generate an interrupt. (See Figure 9)

MODE 3. TIMER WITH CAPTURE REGISTER

Timer T1 can be used to precisely measure external frequencies or events in this mode of operation. The timer T1 counts down at the instruction cycle rate. Upon the occurrence of a specified edge on the TIO pin the contents of the timer T1 are copied into the register R1. Bits in the control register CNTRL allow the trigger edge to be specified either as a positive edge or as a negative edge. In this mode the user can elect to be interrupted on the specified trigger edge. (See Figure 10.)

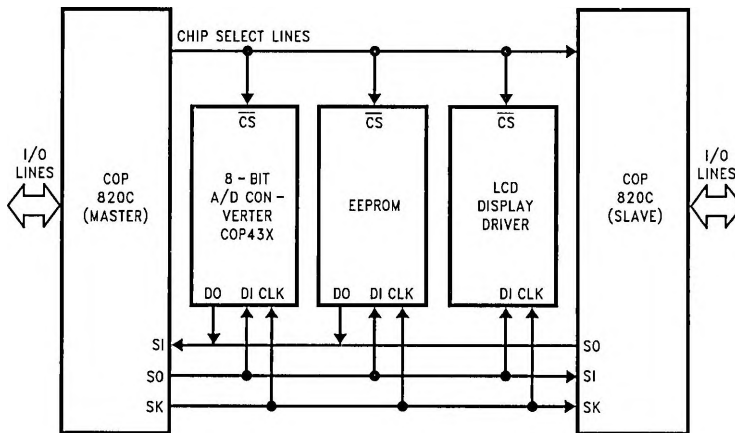

TL/DD/9103-13

FIGURE 8. MICROWIRE/PLUS Application

Functional Description (Continued)

TABLE V. Timer Operating Modes

CNTRL Bits 7 6 5	Operation Mode	T Interrupt	Timer Counts On
0 0 0	External Counter W/Auto-Load Reg.	Timer Underflow	TIO Pos. Edge
0 0 1	External Counter W/Auto-Load Reg.	Timer Underflow	TIO Neg. Edge
0 1 0	Not Allowed	Not Allowed	Not Allowed
0 1 1	Not Allowed	Not Allowed	Not Allowed
1 0 0	Timer W/Auto-Load Reg.	Timer Underflow	t_c
1 0 1	Timer W/Auto-Load Reg./Toggle TIO Out	Timer Underflow	t_c
1 1 0	Timer W/Capture Register	TIO Pos. Edge	t_c
1 1 1	Timer W/Capture Register	TIO Neg. Edge	t_c

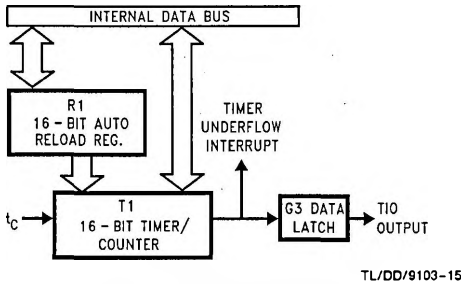

FIGURE 9. Timer/Counter Auto Reload Mode Block Diagram

TL/DD/9103-15

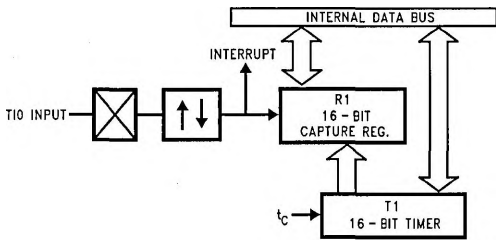

FIGURE 10. Timer Capture Mode Block Diagram

TL/DD/9103-14

TIMER PWM APPLICATION

Figure 11 shows how a minimal component D/A converter can be built out of the Timer-Register pair in the Auto-Reload mode. The timer is placed in the "Timer with auto reload" mode and the TIO pin is selected as the timer output. At the outset the TIO pin is set high, the timer T1 holds the on time and the register R1 holds the signal off time. Setting TRUN bit starts the timer which counts down at the instruction cycle rate. The underflow toggles the TIO output and copies the off time into the timer, which continues to run. By alternately loading in the on time and the off time at each successive interrupt a PWM frequency can be easily generated.

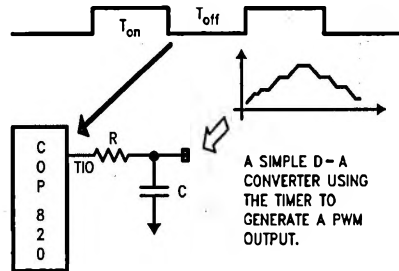

FIGURE 11. Timer Application

TL/DD/9103-16

Instruction Set

REGISTER AND SYMBOL DEFINITIONS

Registers

A	8-bit Accumulator register
B	8-bit Address register
X	8-bit Address register
SP	8-bit Stack pointer register
PC	15-bit Program counter register
PU	upper 7 bits of PC
PL	lower 8 bits of PC
C	1-bit of PSW register for carry
HC	Half Carry
GIE	1-bit of PSW register for global interrupt enable

Symbols

[B]	Memory indirectly addressed by B register
[X]	Memory indirectly addressed by X register
Mem	Direct address memory or [B]
Meml	Direct address memory or [B] or Immediate data
Imm	8-bit Immediate data
Reg	Register memory: addresses F0 to FF (Includes B, X and SP)
Bit	Bit number (0 to 7)
←	Loaded with
↔	Exchanged with

Instruction Set

ADD ADC	add add with carry	A ← A + Meml A ← A + Meml + C, C ← Carry HC ← Half Carry
SUBC	subtract with carry	A ← A + Meml + C, C ← Carry HC ← Half Carry
AND OR XOR	Logical AND Logical OR Logical Exclusive-OR	A ← A and Meml A ← A or Meml A ← A xor Meml
IFEQ IFGT IFBNE DRSZ SBIT	IF equal IF greater than IF B not equal Decrement Reg. ,skip if zero Set bit	Compare A and Meml, Do next if A = Meml Compare A and Meml, Do next if A > Meml Do next if lower 4 bits of B ≠ Imm Reg ← Reg - 1, skip if Reg goes to 0
RBIT	Reset bit	1 to bit, Mem (bit = 0 to 7 immediate)
IFBIT	If bit	0 to bit, Mem If bit, Mem is true, do next instr.
X LD A LD mem LD Reg	Exchange A with memory Load A with memory Load Direct memory Immed. Load Register memory Immed.	A ↔ Mem A ← Meml Mem ← Imm Reg ← Imm
X X LD A LD A LD M	Exchange A with memory [B] Exchange A with memory [X] Load A with memory [B] Load A with memory [X] Load Memory Immediate	A ↔ [B] (B ← B ± 1) A ↔ [X] (X ← X ± 1) A ← [B] (B ← B ± 1) A ← [X] (X ← X ± 1) [B] ← Imm (B ← B ± 1)
CLRA INCA DECA LAID DCORA RRCA SWAPA SC RC IFC IFNC	Clear A Increment A Decrement A Load A indirect from ROM DECIMAL CORRECT A ROTATE A RIGHT THRU C Swap nibbles of A Set C Reset C If C If not C	A ← 0 A ← A + 1 A ← A - 1 A ← ROM(PU,A) A ← BCD correction (follows ADC, SUBC) C → A7 → ... → A0 → C A7 ... A4 ↔ A3 ... A0 C ← 1, HC ← 1 C ← 0, HC ← 0 If C is true, do next instruction If C is not true, do next instruction
JMPL JMP JP JSRL JSR JID RET RETSK RETI INTR NOP	Jump absolute long Jump absolute Jump relative short Jump subroutine long Jump subroutine Jump indirect Return from subroutine Return and Skip Return from Interrupt Generate an interrupt No operation	PC ← ii (ii = 15 bits, 0 to 32k) PC11..0 ← i (i = 12 bits) PC ← PC + r (r is -31 to +32, not 1) [SP] ← PL, [SP-1] ← PU, SP-2, PC ← ii [SP] ← PL, [SP-1] ← PU, SP-2, PC11..0 ← i PL ← ROM(PU,A) SP+2, PL ← [SP], PU ← [SP-1] SP+2, PL ← [SP], PU ← [SP-1], Skip next instruction SP+2, PL ← [SP], PU ← [SP-1], GIE ← 1 [SP] ← PL, [SP-1] ← PU, SP-2, PC ← OFF PC ← PC + 1

OPCODE LIST

Bits 3-0

F	E	D	C	B	A	9	8	7	6	5	4	3	2	1	0
JP -15	JP -31	LD 0F0, #i	DRSZ 0F0	RRCA	RC	ADCA, #i	ADCA, [B]	IFBIT 0, [B]	*	LD B, 0F	IFBNE 0	JSR 0000-00FF	JMP 0000-00FF	JP + 17	INTR
JP -14	JP -30	LD 0F1, #i	DRSZ 0F1	*	SC	SUBCA, #i	SUBC A, [B]	IFBIT 1, [B]	*	LD B, 0E	IFBNE 1	JSR 0100-01FF	JMP 0100-01FF	JP + 18	JP + 2
JP -13	JP -29	LD 0F2, #i	DRSZ 0F2	X A, [X +]	X A, [B +]	IFEQA, #i	IFEQ A, A, [B]	IFBIT 2, [B]	*	LD B, 0D	IFBNE 2	JSR 0200-02FF	JMP 0200-02FF	JP + 19	JP + 3
JP -12	JP -28	LD 0F3, #i	DRSZ 0F3	X A, [X -]	X A, [B -]	IFGTA, #i	IFGT A, A, [B]	IFBIT 3, [B]	*	LD B, 0C	IFBNE 3	JSR 0300-03FF	JMP 0300-03FF	JP + 20	JP + 4
JP -11	JP -27	LD 0F4, #i	DRSZ 0F4	*	LAID	ADD A, #i	ADD A, A, [B]	IFBIT 4, [B]	CLRA	LD B, 0B	IFBNE 4	JSR 0400-04FF	JMP 0400-04FF	JP + 21	JP + 5
JP -10	JP -26	LD 0F5, #i	DRSZ 0F5	*	JID	AND A, #i	AND A, A, [B]	IFBIT 5, [B]	SWAPA	LD B, 0A	IFBNE 5	JSR 0500-05FF	JMP 0500-05FF	JP + 22	JP + 6
JP -9	JP -25	LD 0F6, #i	DRSZ 0F6	X A, [X]	X A, [B]	XOR A, #i	XOR A, A, [B]	IFBIT 6, [B]	DCORA	LD B, 9	IFBNE 6	JSR 0600-06FF	JMP 0600-06FF	JP + 23	JP + 7
JP -8	JP -24	LD 0F7, #i	DRSZ 0F7	*	*	OR A, #i	OR A, A, [B]	IFBIT 7, [B]	*	LD B, 8	IFBNE 7	JSR 0700-07FF	JMP 0700-07FF	JP + 24	JP + 8
JP -7	JP -23	LD 0F8, #i	DRSZ 0F8	NOP	*	LD A, #i	IFC	SBIT 0, [B]	RBIT 0, [B]	LD B, 7	IFBNE 8	JSR 0800-08FF	JMP 0800-08FF	JP + 25	JP + 9
JP -6	JP -22	LD 0F9, #i	DRSZ 0F9	*	*	*	IFNC	SBIT 1, [B]	RBIT 1, [B]	LD B, 6	IFBNE 9	JSR 0900-09FF	JMP 0900-09FF	JP + 26	JP + 10
JP -5	JP -21	LD 0FA, #i	DRSZ 0FA	LD A, [X +]	LD A, [B +]	LD [B +], #i	INCA	SBIT 2, [B]	RBIT 2, [B]	LD B, 5	IFBNE 0A	JSR 0A00-0AFF	JMP 0A00-0AFF	JP + 27	JP + 11
JP -4	JP -20	LD 0FB, #i	DRSZ 0FB	LD A, [X -]	LD A, [B -]	LD [B -], #i	DECA	SBIT 3, [B]	RBIT 3, [B]	LD B, 4	IFBNE 0B	JSR 0B00-0BFF	JMP 0B00-0BFF	JP + 28	JP + 12
JP -3	JP -19	LD 0FC, #i	DRSZ 0FC	LD Md, #i	JMPL #i	X A, Md	*	SBIT 4, [B]	RBIT 4, [B]	LD B, 3	IFBNE 0C	JSR 0C00-0CFF	JMP 0C00-0CFF	JP + 29	JP + 13
JP -2	JP -18	LD 0FD, #i	DRSZ 0FD	DIR	JSRL	LD A, Md	RETSK	SBIT 5, [B]	RBIT 5, [B]	LD B, 2	IFBNE 0D	JSR 0D00-0DFF	JMP 0D00-0DFF	JP + 30	JP + 14
JP -1	JP -17	LD 0FE, #i	DRSZ 0FE	LD A, [X]	LD A, [B]	LD [B], #i	RET	SBIT 6, [B]	RBIT 6, [B]	LD B, 1	IFBNE 0E	JSR 0E00-0EFF	JMP 0E00-0EFF	JP + 31	JP + 15
JP -0	JP -16	LD 0FF, #i	DRSZ 0FF	*	*	*	RETI	SBIT 7, [B]	RBIT 7, [B]	LD B, 0	IFBNE 0F	JSR 0F00-0FFF	JMP 0F00-0FFF	JP + 32	JP + 16

Bits 7-4

* is an unused opcode (see following table)

Md is a directly addressed memory locatio.

i is the immediate data

Instruction Execution Time

Most instructions are single byte (with immediate addressing mode instruction taking two bytes).

Most single instructions take one cycle time to execute.

See the BYTES and CYCLES per INSTRUCTION table for details.

BYTES and CYCLES per INSTRUCTION

The following table shows the number of bytes and cycles for each instruction in the format of byte/cycle.

Arithmetic and Logic Instructions

	[B]	Direct	Immed.
ADD	1/1	3/4	2/2
ADC	1/1	3/4	2/2
SUBC	1/1	3/4	2/2
AND	1/1	3/4	2/2
OR	1/1	3/4	2/2
XOR	1/1	3/4	2/2
IFEQ	1/1	3/4	2/2
IFGT	1/1	3/4	2/2
IFBNE	1/1		
DRSZ		1/3	
SBIT	1/1	3/4	
RBIT	1/1	3/4	
IFBIT	1/1	3/4	

Memory Transfer Instructions

	Register Indirect [B] [X]		Direct	Immed.	Register Indirect Auto Incr & Decr [B+, B-] [X+, X-]	
X A,*	1/1	1/3	2/3		1/2	1/3
LD A,*	1/1	1/3	2/3	2/2	1/2	1/3
LD B,Imm				1/1		
LD B,Imm				2/3		
LD Mem,Imm	2/2		3/3		2/2	
LD Reg,Imm				2/3		

(If B < 16)

(If B > 15)

* = > Memory location addressed by B or X or directly.

Instructions Using A & C

CLRA	1/1
INCA	1/1
DECA	1/1
LAID	1/3
DCORA	1/1
RRCA	1/1
SWAPA	1/1
SC	1/1
RC	1/1
IFC	1/1
IFNC	1/1

Transfer of Control Instructions

JMPL	3/4
JMP	2/3
JP	1/3
JSRL	3/5
JSR	2/5
JID	1/3
RET	1/5
RETSK	1/5
RETI	1/5
INTR	1/7
NOP	1/1

The following table shows the instructions assigned to unused opcodes. This table is for information only. The operations performed are subject to change without notice. Do not use these opcodes.

Unused Opcode	Instruction	Unused Opcode	Instruction
60	NOP	A9	NOP
61	NOP	AF	LD A, [B]
62	NOP	B1	C → HC
63	NOP	B4	NOP
67	NOP	B5	NOP
8C	RET	B7	X A, [X]
99	NOP	B9	NOP
9F	LD [B], #i	BF	LD A, [X]
A7	X A, [B]		
A8	NOP		

Option List

The mask programmable options are listed out below. The options are programmed at the same time as the ROM pattern to provide the user with hardware flexibility to use a variety of oscillator configuration.

OPTION 1: CKI INPUT

- = 1 Crystal (CKI/10) CKO for crystal configuration
- = 2 External (CKI/10) CKO available as G7 input
- = 3 R/C (CKI/10) CKO available as G7 input

OPTION 2: BONDING

- = 1 28 pin package
- = 2 N.A.
- = 3 20 pin package
- = 4 20 SO package
- = 5 28 SO package

The following option information is to be sent to National along with the EPROM.

Option Data

Option 1 Value__is: CKI Input

Option 2 Value__is: COP Bonding

How to Order

To order a complete development package, select the section for the microcontroller to be developed and order the parts listed. Contact the sales office for more detail.

Development Support

IN-CIRCUIT EMULATOR

The MetaLink iceMASTER™—COP8 Model 400 In-Circuit Emulator for the COP8 family of microcontrollers features high-performance operation, ease of use, and an extremely flexible user-interface for maximum productivity. Interchangeable probe cards, which connect to the standard common base, support the various configurations and packages of the COP8 family.

The iceMASTER provides real time, full speed emulation up to 10 MHz, 32 kBytes of emulation memory and 4k frames of trace buffer memory. The user may define as many as

32k trace and break triggers which can be enabled, disabled, set or cleared. They can be simple triggers based on code or address ranges or complex triggers based on code address, direct address, opcode value, opcode class or immediate operand. Complex breakpoints can be ANDed and ORed together. Trace information consists of address bus values, opcodes and user selectable probe clips status (external event lines). The trace buffer can be viewed as raw hex or as disassembled instructions. The probe clip bit values can be displayed in binary, hex or digital waveform formats.

During single-step operation the dynamically annotated code feature displays the contents of all accessed (read and write) memory locations and registers, as well as flow-of-control direction change markers next to each instruction executed.

The iceMASTER's performance analyzer offers a resolution of better than 6 μ s. The user can easily monitor the time spent executing specific portions of code and find "hot spots" or "dead code". Up to 15 independent memory areas based on code address or label ranges can be defined. Analysis results can be viewed in bargraph format or as actual frequency count.

Emulator memory operations for program memory include single line assembler, disassembler, view, change and write to file. Data memory operations include fill, move, compare, dump to file, examine and modify. The contents of any memory space can be directly viewed and modified from the corresponding window.

The iceMASTER comes with an easy to use windowed interface. Each window can be sized, highlighted, color-controlled, added, or removed completely. Commands can be accessed via pull-down-menus and/or redefineable hot keys. A context sensitive hypertext/hyperlinked on-line help system explains clearly the options the user has from within any window.

The iceMASTER connects easily to a PC via the standard COMM port and its 115.2 kBaud serial link keeps typical program download time to under 3 seconds.

The following tables list the emulator and probe cards ordering information:

Emulator Ordering Information

Part Number	Description	Current Version
IM-COP8/400/1‡	MetaLink base unit in-circuit emulator for all COP8 devices, symbolic debugger software and RS-232 serial interface cable, with 110V @ 60 Hz Power Supply.	HOST SOFTWARE: VER. 3.3 REV.5, Model File Rev 3.050.
IM-COP8/400/2‡	MetaLink base unit in-circuit emulator for all COP8 devices, symbolic debugger software and RS-232 serial interface cable, with 220V @ 50 Hz Power Supply.	
DM-COP8/880/‡	MetaLink iceMASTER Debug Module. This is the low cost version of the MetaLink iceMASTER. Firmware: Ver.6.07.	

‡These parts include National's COP8 Assembler/Linker/Librarian Package (COP8-DEV-IBMA)

Development Support (Continued)**Probe Card Ordering Information**

Part Number	Package	Voltage Range	Emulates
MHW-880C20D5PC	20 DIP	4.5V–5.5V	COP822C, 842C, 8782C
MHW-880C20DWPC	20 DIP	2.5V–6.0V	COP822C, 842C, 8782C
MHW-880C28D5PC	28 DIP	4.5V–5.5V	COP820C, 840C, 881C, 8781C
MHW-880C28DWPC	28 DIP	2.5V–6.0V	COP820C, 840C, 881C, 8781C

MACRO CROSS ASSEMBLER

National Semiconductor offers a COP8 macro cross assembler. It runs on industry standard compatible PCs and supports all of the full-symbolic debugging features of the MetaLink iceMASTER emulators.

SINGLE CHIP EMULATOR DEVICE

The COP8 family is fully supported by single chip form, fit, and function emulators. For more detailed information refer to the emulation device specific data sheets and the emulator selection table below.

Assembler Ordering Information

Part Number	Description	Manual
COP8-DEV-IBMA	COP8 Assembler/ Linker/Librarian for IBM®, PC-XT®, AT® or compatible	424410632-001

Single Chip Emulator Selection Table

Device Number	Clock Option	Package	Description	Emulates
COP8781CN	Programmable	28 DIP	One Time Programmable (OTP)	COP840C, COP820C
COP8781CJ	Programmable	28 DIP	UV Erasable	COP840C, COP820C
COP8781CWM	Programmable	28 SO	OTP	COP840C, COP820C
COP8782CN	Programmable	20 DIP	OTP	COP842C, COP822C
COP8782CJ	Programmable	20 DIP	UV Erasable	COP842C, COP822C
COP8782CWM	Programmable	20 SO	OTP	COP842C, COP822C

Development Support (Continued)**PROGRAMMING SUPPORT**

Programming of the single chip emulator devices is supported by different sources. The following programmers are certified for programming the One Time Programmable (OTP) devices:

EPROM Programmer Information

Manufacturer and Product	U.S. Phone Number	Europe Phone Number	Asia Phone Number
MetaLink-Debug Module	(602) 926-0797	Germany: + 49-81-41-1030	Hong Kong: + 852-737-1800
Xeltek-Superpro	(408) 745-7974	Germany: + 49-20-41 684758	Singapore: + 65 276 6433
BP Microsystems-EP-1140	(800) 225-2102	Germany: + 49-89-857 66 67	Hong Kong: + 852 388 0629
Data I/O- Unisite; -System 29, -System 39	(800) 322-8246	Europe: + 31-20-622866 Germany: + 49-89-85-8020	Japan: + 33-432-6991
Abcom- COP8 Programmer		Europe: + 89 80 8707	
System General Turpro-1-FX; -APRO	(408) 263-6667	Switzerland: + 31-921-7844	Taiwan Taipei: + 2-9173005

INFORMATION SYSTEM

The Dial-A-Helper system provides access to an automated information storage and retrieval system that may be accessed over standard dial-up telephone lines 24 hours a day. The system capabilities include a MESSAGE SECTION (electronic mail) for communications to and from the Microcontroller Applications Group and a FILE SECTION which consists of several file areas where valuable application software and utilities could be found. The minimum requirement for accessing the Dial-A-Helper is a Hayes compatible modem.

If the user has a PC with a communications package then files from the FILE SECTION can be down-loaded to disk for later use.

ORDER P/N: MOLE-DIAL-A-HLP

Information System Package contains:

Dial-A-Helper Users Manual

Public Domain Communications Software

FACTORY APPLICATIONS SUPPORT

Dial-A-Helper also provides immediate factory applications support. If a user has questions, he can leave messages on our electronic bulletin board, which we will respond to.

Voice: (800) 272-9999

Modem: CANADA/U.S.: (800) NSC-MICRO

(800) 672-6427

Baud: 14.4k

Setup: Length: 8-Bit

Parity: None

Stop Bit: 1

Operation: 24 Hrs. 7 Days