



National
Semiconductor
Corporation

LM109/LM309 5-Volt Regulator

General Description

The LM109 series are complete 5V regulators fabricated on a single silicon chip. They are designed for local regulation on digital logic cards, eliminating the distribution problems associated with single-point regulation. The devices are available in two standard transistor packages. In the solid-kovar TO-5 header, it can deliver output currents in excess of 200 mA, if adequate heat sinking is provided. With the TO-3 power package, the available output current is greater than 1A.

The regulators are essentially blowout proof. Current limiting is included to limit the peak output current to a safe value. In addition, thermal shutdown is provided to keep the IC from overheating. If internal dissipation becomes too great, the regulator will shut down to prevent excessive heating.

Considerable effort was expended to make these devices easy to use and to minimize the number of external components. It is not necessary to bypass the output, although this does improve transient response somewhat. Input bypassing is needed, however, if the regulator is located very

far from the filter capacitor of the power supply. Stability is also achieved by methods that provide very good rejection of load or line transients as are usually seen with TTL logic.

Although designed primarily as a fixed-voltage regulator, the output of the LM109 series can be set to voltages above 5V, as shown. It is also possible to use the circuits as the control element in precision regulators, taking advantage of the good current-handling capability and the thermal overload protection.

Features

- Specified to be compatible, worst case, with TTL and DTL
- Output current in excess of 1A
- Internal thermal overload protection
- No external components required

Schematic Diagram

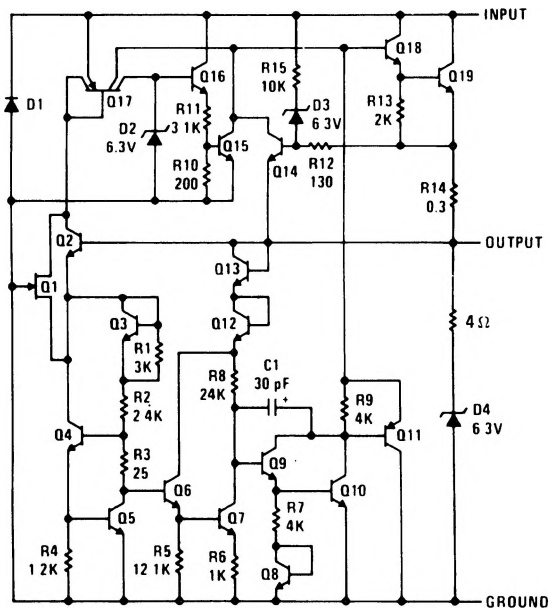

Absolute Maximum Ratings

If Military/Aerospace specified devices are required, contact the National Semiconductor Sales Office/Distributors for availability and specifications.

(Note 3)

Input Voltage 35V
Power Dissipation Internally Limited

Operating Junction Temperature Range

LM109 -55°C to +150°C

LM309 0°C to +125°C

Storage Temperature Range

Lead Temperature (Soldering, 10 sec.) -65°C to +150°C 300°C

Electrical Characteristics (Note 1)

Parameter	Conditions	LM109			LM309			Units
		Min	Typ	Max	Min	Typ	Max	
Output Voltage	$T_j = 25^\circ\text{C}$	4.7	5.05	5.3	4.8	5.05	5.2	V
Line Regulation	$T_j = 25^\circ\text{C}$ $7.10\text{V} \leq V_{IN} \leq 25\text{V}$		4.0	50		4.0	50	mV
Load Regulation	$T_j = 25^\circ\text{C}$ TO-5 Package TO-3 Package							
	$5\text{ mA} \leq I_{OUT} \leq 0.5\text{A}$		15	50		15	50	mV
	$5\text{ mA} \leq I_{OUT} \leq 1.5\text{A}$		15	100		15	100	mV
Output Voltage	$7.40\text{V} \leq V_{IN} \leq 25\text{V}$, $5\text{ mA} \leq I_{OUT} \leq I_{MAX}$, $P < P_{MAX}$	4.6		5.4	4.75		5.25	V
Quiescent Current	$7.40\text{V} \leq V_{IN} \leq 25\text{V}$		5.2	10		5.2	10	mA
Quiescent Current Change	$7.40\text{V} \leq V_{IN} \leq 25\text{V}$ $5\text{ mA} \leq I_{OUT} \leq I_{MAX}$			0.5		0.5	0.5	mA
				0.8		0.8	0.8	mA
Output Noise Voltage	$T_A = 25^\circ\text{C}$ $10\text{ Hz} \leq f \leq 100\text{ kHz}$		40			40		μV
Long Term Stability			10			20		mV
Ripple Rejection	$T_j = 25^\circ\text{C}$	50			50			dB
Thermal Resistance,	(Note 2)							
Junction to Case								
TO-5 Package			15			15		$^\circ\text{C}/\text{W}$
TO-3 Package			2.5			2.5		$^\circ\text{C}/\text{W}$

Note 1: Unless otherwise specified, these specifications apply $-55^\circ\text{C} \leq T_j \leq +150^\circ\text{C}$ for the LM109 and $0^\circ\text{C} \leq T_j \leq +125^\circ\text{C}$ for the LM309; $V_{IN} = 10\text{V}$; and $I_{OUT} = 0.1\text{A}$ for the TO-39 package or $I_{OUT} = 0.5\text{A}$ for the TO-3 package. For the TO-39 package, $I_{MAX} = 0.2\text{A}$ and $P_{MAX} = 2.0\text{W}$. For the TO-3 package, $I_{MAX} = 1.0\text{A}$ and $P_{MAX} = 20\text{W}$.

Note 2: Without a heat sink, the thermal resistance of the TO-39 package is about $150^\circ\text{C}/\text{W}$, while that of the TO-3 package is approximately $35^\circ\text{C}/\text{W}$. With a heat sink, the effective thermal resistance can only approach the values specified, depending on the efficiency of the sink.

Note 3: Refer to RETS109H drawing for LM109H or RETS109K drawing for LM109K military specifications.

Connection Diagrams

Metal Can Packages

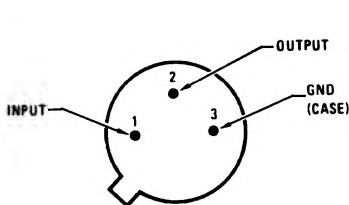

Order Number LM109H or LM309H
See NS Package Number H03A

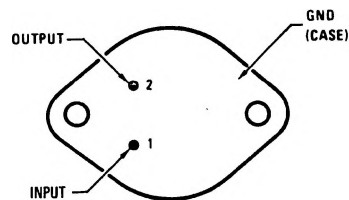

Order Number LM109K STEEL or LM309K STEEL
See NS Package Number K02A

Order Number LM309K (ALUMINUM)
See NS Package Number KC02A

TL/H/7138-3

Application Hints

- Bypass the input** of the LM109 to ground with $\geq 0.2 \mu\text{F}$ ceramic or solid tantalum capacitor if main filter capacitor is more than 4 inches away.
- Use steel package** instead of aluminum if more than 5,000 thermal cycles are expected. ($\Delta T \geq 50^\circ\text{C}$)
- Avoid insertion of regulator into "live" socket** if input voltage is greater than 10V. The output will rise to within 2V of the unregulated input if the ground pin does not make contact, possibly damaging the load. The LM109 may also be damaged if a large output capacitor is charged up, then discharged through the internal clamp zener when the ground pin makes contact.
- The output clamp zener** is designed to absorb transients only. It will not clamp the output effectively if a failure occurs in the internal power transistor structure. Zener dynamic impedance is $\approx 4\Omega$. Continuous RMS current into the zener should not exceed 0.5A.
- Paralleling of LM109s** for higher output current is not recommended. Current sharing will be almost nonexistent, leading to a current limit mode operation for devices with the highest initial output voltage. The current limit devices may also heat up to the thermal shutdown point ($\approx 175^\circ\text{C}$). Long term reliability cannot be guaranteed under these conditions.

f. Preventing latching for loads connected to negative voltage:

If the output of the LM109 is pulled negative by a high current supply so that the output pin is more than 0.5V negative with respect to the ground pin, the LM109 can latch off. This can be prevented by clamping the ground pin to the output pin with a germanium or Schottky diode as shown. A silicon diode (1N4001) at the output is also needed to keep the positive output from being pulled too far negative. The 10Ω resistor will raise $+V_{\text{OUT}}$ by $\approx 0.05\text{V}$.

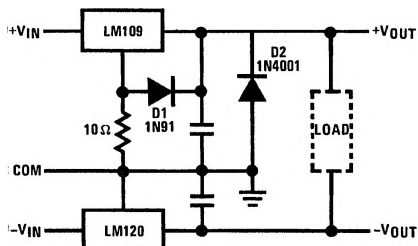

TL/H/7138-7

Crowbar Overvoltage Protection

Input Crowbar

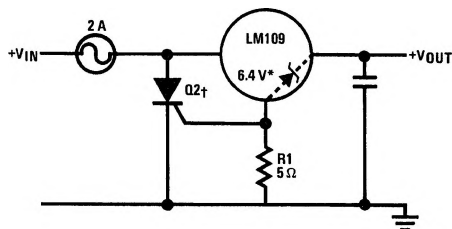

TL/H/7138-8

Output Crowbar

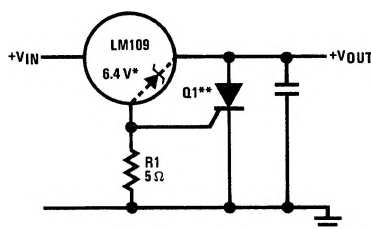

TL/H/7138-9

*Zener is internal to LM109.

**Q1 must be able to withstand 7A continuous current if fusing is not used at regulator input. LM109 bond wires will fuse at currents above 7A.

†Q2 is selected for surge capability. Consideration must be given to filter capacitor size, transformer impedance, and fuse blowing time.

††Trip point is $\approx 7.5\text{V}$.

Typical Performance Characteristics

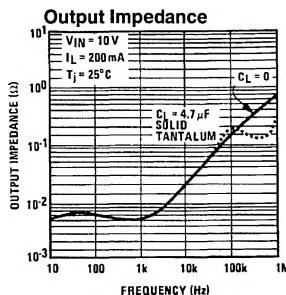
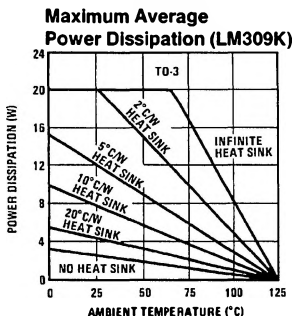
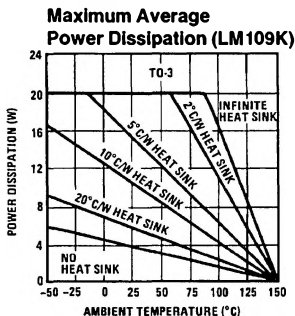

TL/H/7138-10

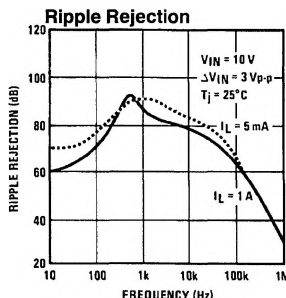
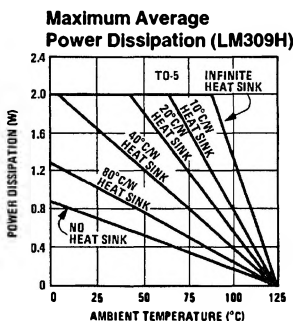
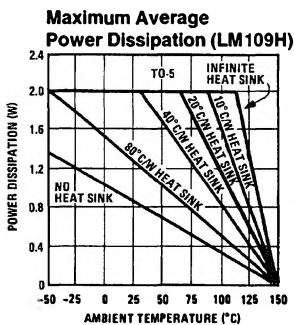

TL/H/7138-11

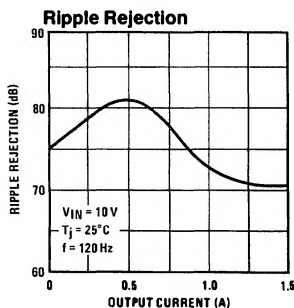
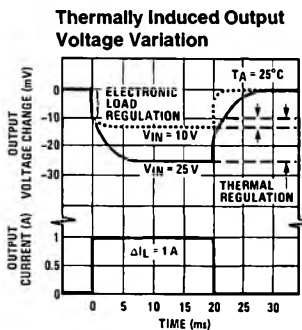
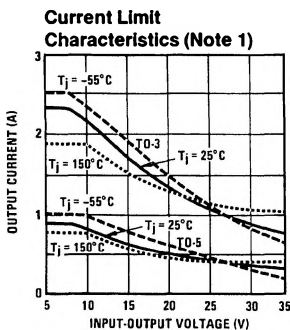

TL/H/7138-12

Note 1: Current limiting foldback characteristics are determined by input output differential, not by output voltage.

Typical Performance Characteristics (Continued)

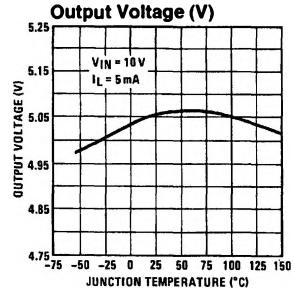
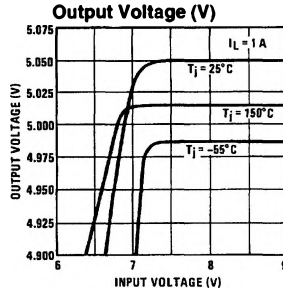
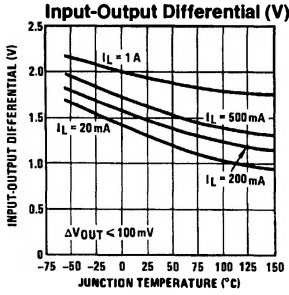

TL/H/7138-13

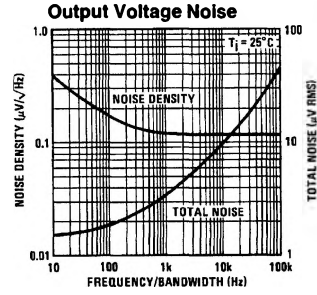
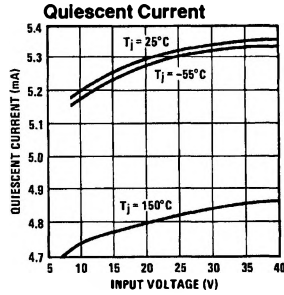
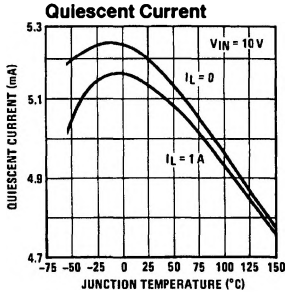

TL/H/7138-14

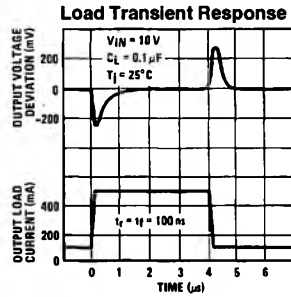
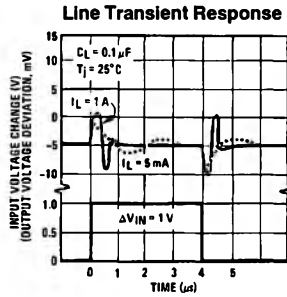

TL/H/7138-15

Typical Applications

Fixed 5V Regulator

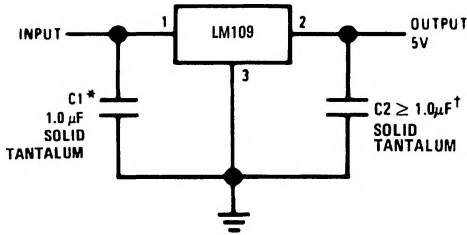

TL/H/7138-2

Adjustable Output Regulator

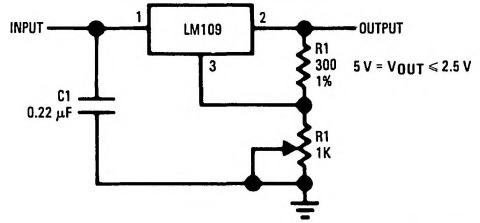

TL/H/7138-4

*Required if regulator is located more than 4" from power supply filter capacitor.

†Although no output capacitor is needed for stability, it does improve transient response.

C2 should be used whenever long wires are used to connect to the load, or when transient response is critical.

Note: Pin 3 electrically connected to case.

High Stability Regulator*

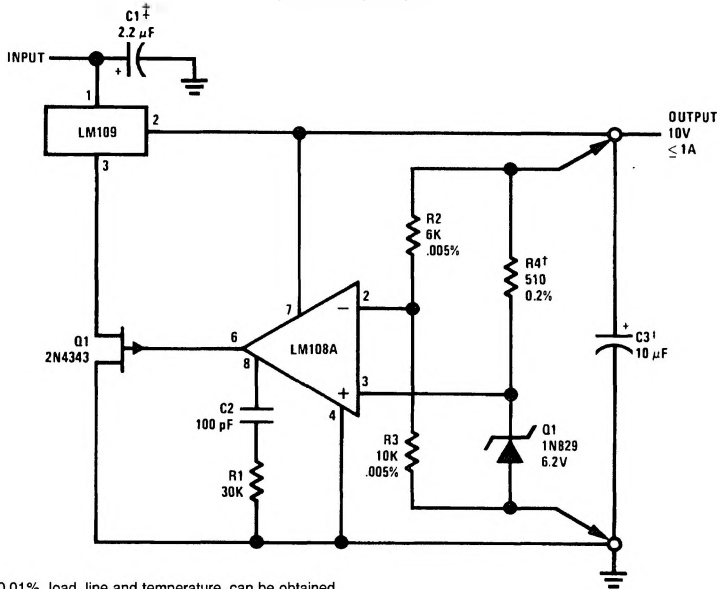

TL/H/7138-5

*Regulation better than 0.01%, load, line and temperature, can be obtained.

†Determines zener current. May be adjusted to minimize thermal drift.

‡Solid tantalum.

Current Regulator

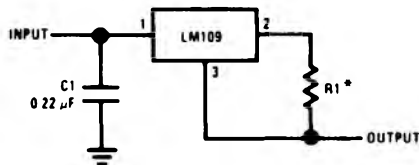

TL/H/7138-6

*Determines output current. If wirewound resistor is used, bypass with 0.1 μF.