

LM3500 Synchronous Step-up DC/DC Converter for White LED Applications

Check for Samples: [LM3500](#)

FEATURES

- Synchronous Rectification, High Efficiency and no External Schottky Diode Required
- Uses Small Surface Mount Components
- Can Drive 2-5 White LEDs in Series
 - (May Function With More Low- V_F LEDs)
- 2.7V to 7V Input Range
- Internal Output Over-Voltage Protection (OVP) Circuitry, with no External Zener Diode Required
 - LM3500-16: 15.5V OVP; LM3500-21: 20.5V OVP.
- True Shutdown Isolation
- Input Undervoltage Lockout
- Requires Only Small Ceramic Capacitors at the

Input and Output

- Thermal Shutdown
- 0.1 μ A Shutdown Current
- Small 8-Bump Thin DSBGA Package

APPLICATIONS

- LCD Bias Supplies
- White LED Backlighting
- Handheld Devices
- Digital Cameras
- Portable Applications

DESCRIPTION

The LM3500 is a fixed-frequency step-up DC/DC converter that is ideal for driving white LEDs for display backlighting and other lighting functions. With fully integrated synchronous switching (no external schottky diode required) and a low feedback voltage (500mV), power efficiency of the LM3500 circuit has been optimized for lighting applications in wireless phones and other portable products (single cell Li-Ion or 3-cell NiMH battery supplies). The LM3500 operates with a fixed 1MHz switching frequency. When used with ceramic input and output capacitors, the LM3500 provides a small, low-noise, low-cost solution.

Two LM3500 options are available with different output voltage capabilities. The LM3500-21 has a maximum output voltage of 21V and is typically suited for driving 4 or 5 white LEDs in series. The LM3500-16 has a maximum output voltage of 16V and is typically suited for driving 3 or 4 white LEDs in series (maximum number of series LEDs dependent on LED forward voltage). If the primary white LED network should be disconnected, the LM3500 uses internal protection circuitry on the output to prevent a destructive over-voltage event.

A single external resistor is used to set the maximum LED current in LED-drive applications. The LED current can easily be adjusted using a pulse width modulated (PWM) signal on the shutdown pin. In shutdown, the LM3500 completely disconnects the input from output, creating total isolation and preventing any leakage currents from trickling into the LEDs.

Typical Application Circuit

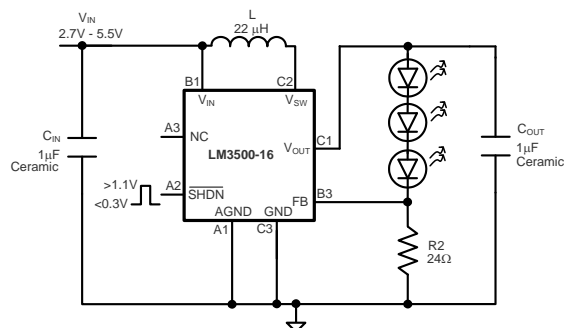

Please be aware that an important notice concerning availability, standard warranty, and use in critical applications of Texas Instruments semiconductor products and disclaimers thereto appears at the end of this data sheet.

All trademarks are the property of their respective owners.

Connection Diagram

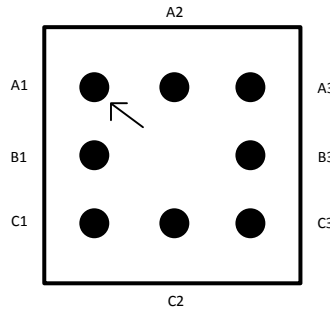

Figure 1. 8-bump DSBGA

PIN FUNCTIONS

Pin	Name	Function
A1	AGND	Analog ground.
B1	V_{IN}	Analog and Power supply input.
C1	V_{OUT}	PMOS source connection for synchronous rectification.
C2	V_{SW}	Switch pin. Drain connections of both NMOS and PMOS power devices.
C3	GND	Power Ground.
B3	FB	Output voltage feedback connection.
A3	NC	No internal connection made to this pin.
A2	$\overline{\text{SHDN}}$	Shutdown control pin.

AGND(pin A1): Analog ground pin. The analog ground pin should tie directly to the GND pin.

V_{IN} (pin B1): Analog and Power supply pin. Bypass this pin with a capacitor, as close to the device as possible, connected between the V_{IN} and GND pins.

V_{OUT} (pin C1): Source connection of internal PMOS power device. Connect the output capacitor between the V_{OUT} and GND pins as close as possible to the device.

V_{SW} (pin C2): Drain connection of internal NMOS and PMOS switch devices. Keep the inductor connection close to this pin to minimize EMI radiation.

GND(pin C3): Power ground pin. Tie directly to ground plane.

FB(pin B3): Output voltage feedback connection. Set the primary White LED network current with a resistor from the FB pin to GND. Keep the current setting resistor close to the device and connected between the FB and GND pins.

NC(pin A3): No internal connection is made to this pin. The maximum allowable voltage that can be applied to this pin is 7.5V.

$\overline{\text{SHDN}}$ (pin A2): Shutdown control pin. Disable the device with a voltage less than 0.3V and enable the device with a voltage greater than 1.1V. The white LED current can be controlled using a PWM signal at this pin. There is an internal pull down on the $\overline{\text{SHDN}}$ pin, the device is in a normally off state.



These devices have limited built-in ESD protection. The leads should be shorted together or the device placed in conductive foam during storage or handling to prevent electrostatic damage to the MOS gates.

Absolute Maximum Ratings⁽¹⁾⁽²⁾

V_{IN}		-0.3V to 7.5V
V_{OUT} (LM3500-16) ⁽³⁾		-0.3V to 16V
V_{OUT} (LM3500-21) ⁽³⁾		-0.3V to 21V
V_{SW} ⁽³⁾		-0.3V to $V_{OUT}+0.3V$
FB, \overline{SHDN} , and NC Voltages		-0.3V to 7.5V
Maximum Junction Temperature		150°C
Lead Temperature ⁽⁴⁾		300°C
ESD Ratings ⁽⁵⁾	Human Body Model	2kV
	Machine Model	200V

- (1) Absolute maximum ratings are limits beyond which damage to the device may occur. Operating Ratings are conditions for which the device is intended to be functional, but device parameter specifications may not be guaranteed. For guaranteed specifications and test conditions, see the Electrical Characteristics.
- (2) If Military/Aerospace specified devices are required, please contact the Texas Instruments Sales Office/ Distributors for availability and specifications.
- (3) This condition applies if $V_{IN} < V_{OUT}$. If $V_{IN} > V_{OUT}$, a voltage greater than $V_{IN} + 0.3V$ should not be applied to the V_{OUT} or V_{SW} pins.
- (4) For more detailed soldering information and specifications, please refer to National Semiconductor Application Note 1112: DSBGA Wafer Level Chip Scale Package (AN-1112), available at www.national.com.
- (5) The human body model is a 100 pF capacitor discharged through a 1.5 k Ω resistor into each pin. The machine model is a 200 pF capacitor discharged directly into each pin.

Operating Conditions

Ambient Temperature ⁽¹⁾	-40°C to +85°C
Junction Temperature	-40°C to +125°C
Supply Voltage	2.7V to 7V

- (1) In applications where high power dissipation and/or poor package thermal resistance is present, the maximum ambient temperature may have to be derated. Maximum ambient temperature (T_{A-MAX}) is dependent on the maximum operating junction temperature ($T_{J-MAX-OP} = 125^\circ\text{C}$), the maximum power dissipation of the device in the application (P_{D-MAX}), and the junction-to ambient thermal resistance of the part/package in the application (θ_{JA}), as given by the following equation: $T_{A-MAX} = T_{J-MAX-OP} - (\theta_{JA} \times P_{D-MAX})$.

Thermal Properties

Junction to Ambient Thermal Resistance (θ_{JA}) ⁽¹⁾	75°C/W
---	--------

- (1) Junction-to-ambient thermal resistance (θ_{JA}) is highly application and board-layout dependent. The 75°C/W figure provided was measured on a 4-layer test board conforming to JEDEC standards. In applications where high maximum power dissipation exists, special care must be paid to thermal dissipation issues when designing the board layout.

Electrical Characteristics

Specifications in standard type face are for $T_A = 25^\circ\text{C}$ and those in **boldface type** apply over the Operating Temperature Range of $T_A = -10^\circ\text{C}$ to $+85^\circ\text{C}$. Unless otherwise specified $V_{IN} = 2.7\text{V}$ and specification apply to both LM3500-16 and LM3500-21.

Symbol	Parameter	Conditions	Min ⁽¹⁾	Typ ⁽²⁾	Max ⁽¹⁾	Units
I_Q	Quiescent Current, Device Not Switching	$FB > 0.54\text{V}$		0.95	1.2	mA
	Quiescent Current, Device Switching	$FB = 0\text{V}$		1.8	2.5	
	Shutdown	$\overline{\text{SHDN}} = 0\text{V}$		0.1	2	μA
V_{FB}	Feedback Voltage	$V_{IN} = 2.7\text{V}$ to 7V	0.47	0.5	0.53	V
ΔV_{FB}	Feedback Voltage Line Regulation	$V_{IN} = 2.7\text{V}$ to 7V		0.1	0.4	%/V
I_{CL}	Switch Current Limit (LM3500-16)	$V_{IN} = 2.7\text{V}$, Duty Cycle = 80%	275	400	480	mA
		$V_{IN} = 3.0\text{V}$, Duty Cycle = 70%	255	400	530	
	Switch Current Limit (LM3500-21)	$V_{IN} = 2.7\text{V}$, Duty Cycle = 70%	420	640	770	
		$V_{IN} = 3.0\text{V}$, Duty Cycle = 63%	450	670	800	
I_B	FB Pin Bias Current	$FB = 0.5\text{V}^{(3)}$		45	200	nA
V_{IN}	Input Voltage Range		2.7		7.0	V
$R_{DS(on)}$	NMOS Switch $R_{DS(on)}$	$V_{IN} = 2.7\text{V}$, $I_{SW} = 300\text{mA}$			0.43	Ω
	PMOS Switch $R_{DS(on)}$	$V_{OUT} = 6\text{V}$, $I_{SW} = 300\text{mA}$		1.1	2.3	
D_{Limit}	Duty Cycle Limit (LM3500-16)	$FB = 0\text{V}$	80	87		%
	Duty Cycle Limit (LM3500-21)	$FB = 0\text{V}$	85	94		
F_{SW}	Switching Frequency		0.85	1.0	1.15	MHz
I_{SD}	$\overline{\text{SHDN}}$ Pin Current ⁽⁴⁾	$\overline{\text{SHDN}} = 5.5\text{V}$		18	30	μA
		$\overline{\text{SHDN}} = 2.7\text{V}$		9	16	
		$\overline{\text{SHDN}} = \text{GND}$		0.1		
I_L	Switch Leakage Current (LM3500-16)	$V_{SW} = 15\text{V}$		0.01	0.5	μA
	Switch Leakage Current (LM3500-21)	$V_{SW} = 20\text{V}$		0.01	2.0	
UVP	Input Undervoltage Lockout	ON Threshold	2.4	2.5	2.6	V
		OFF Threshold	2.3	2.4	2.5	
OVP	Output Overvoltage Protection (LM3500-16)	ON Threshold	15	15.5	16	V
		OFF Threshold	14	14.6	15	
	Output Overvoltage Protection (LM3500-21)	ON Threshold	20	20.5	21	
		OFF Threshold	19	19.5	20	
I_{Vout}	V_{OUT} Bias Current (LM3500-16)	$V_{OUT} = 15\text{V}$, $\overline{\text{SHDN}} = V_{IN}$		260	400	μA
	V_{OUT} Bias Current (LM3500-21)	$V_{OUT} = 20\text{V}$, $\overline{\text{SHDN}} = V_{IN}$		300	460	
I_{VL}	PMOS Switch Leakage Current (LM3500-16)	$V_{OUT} = 15\text{V}$, $V_{SW} = 0\text{V}$		0.01	3	μA
	PMOS Switch Leakage Current (LM3500-21)	$V_{OUT} = 20\text{V}$, $V_{SW} = 0\text{V}$		0.01	3	

- (1) All limits guaranteed at room temperature (standard typeface) and at temperature extremes (bold typeface). All room temperature limits are production tested, guaranteed through statistical analysis or guaranteed by design. All limits at temperature extremes are guaranteed via correlation using standard Statistical Quality Control (SQC) methods. All limits are used to calculate Average Outgoing Quality Level (AOQL).
- (2) Typical numbers are at 25°C and represent the most likely norm.
- (3) Feedback current flows out of the pin.
- (4) Current flows into the pin.

Electrical Characteristics (continued)

Specifications in standard type face are for $T_A = 25^\circ\text{C}$ and those in **boldface type** apply over the Operating Temperature Range of $T_A = -10^\circ\text{C}$ to $+85^\circ\text{C}$. Unless otherwise specified $V_{IN} = 2.7\text{V}$ and specification apply to both LM3500-16 and LM3500-21.

Symbol	Parameter	Conditions	Min ⁽¹⁾	Typ ⁽²⁾	Max ⁽¹⁾	Units
SHDN Threshold	SHDN Low			0.65	0.3	V
	SHDN High		1.1	0.65		

Electrical Characteristics

Specifications in standard type face are for $T_J = 25^\circ\text{C}$ and those in **boldface type** apply over the full **Operating Temperature Range ($T_J = -40^\circ\text{C}$ to $+125^\circ\text{C}$)**. Unless otherwise specified $V_{IN} = 2.7\text{V}$ and specification apply to both LM3500-16 and LM3500-21.

Symbol	Parameter	Conditions	Min ⁽¹⁾	Typ ⁽²⁾	Max ⁽¹⁾	Units
I_Q	Quiescent Current, Device Not Switching	$FB > 0.54\text{V}$		0.95	1.2	mA
	Quiescent Current, Device Switching	$FB = 0\text{V}$		1.8	2.5	
	Shutdown	$\overline{\text{SHDN}} = 0\text{V}$		0.1	2	μA
V_{FB}	Feedback Voltage	$V_{IN} = 2.7\text{V}$ to 7V	0.47	0.5	0.53	V
ΔV_{FB}	Feedback Voltage Line Regulation	$V_{IN} = 2.7\text{V}$ to 7V		0.1	0.4	%/V
I_{CL}	Switch Current Limit (LM3500-16)	$V_{IN} = 3.0\text{V}$, Duty Cycle = 70%		400		mA
	Switch Current Limit (LM3500-21)	$V_{IN} = 3.0\text{V}$, Duty Cycle = 63%		670		
I_B	FB Pin Bias Current	$FB = 0.5\text{V}$ ⁽³⁾		45	200	nA
V_{IN}	Input Voltage Range		2.7		7.0	V
$R_{DS(on)}$	NMOS Switch $R_{DS(on)}$	$V_{IN} = 2.7\text{V}$, $I_{SW} = 300\text{mA}$			0.43	Ω
	PMOS Switch $R_{DS(on)}$	$V_{OUT} = 6\text{V}$, $I_{SW} = 300\text{mA}$		1.1	2.3	
D_{Limit}	Duty Cycle Limit (LM3500-16)	$FB = 0\text{V}$		87		%
	Duty Cycle Limit (LM3500-21)	$FB = 0\text{V}$		94		
F_{SW}	Switching Frequency		0.8	1.0	1.2	MHz
I_{SD}	SHDN Pin Current ⁽⁴⁾	$\overline{\text{SHDN}} = 5.5\text{V}$		18	30	μA
		$\overline{\text{SHDN}} = 2.7\text{V}$		9	16	
		$\overline{\text{SHDN}} = \text{GND}$		0.1		
I_L	Switch Leakage Current (LM3500-16)	$V_{SW} = 15\text{V}$		0.01	0.5	μA
	Switch Leakage Current (LM3500-21)	$V_{SW} = 20\text{V}$		0.01	2.0	
UVP	Input Undervoltage Lockout	ON Threshold	2.4	2.5	2.6	V
		OFF Threshold	2.3	2.4	2.5	
OVP	Output Overvoltage Protection (LM3500-16)	ON Threshold	15	15.5	16	V
		OFF Threshold	14	14.6	15	
	Output Overvoltage Protection (LM3500-21)	ON Threshold	20	20.5	21	
		OFF Threshold	19	19.5	20	

(1) All limits guaranteed at room temperature (standard typeface) and at temperature extremes (bold typeface). All room temperature limits are production tested, guaranteed through statistical analysis or guaranteed by design. All limits at temperature extremes are guaranteed via correlation using standard Statistical Quality Control (SQC) methods. All limits are used to calculate Average Outgoing Quality Level (AOQL).

(2) Typical numbers are at 25°C and represent the most likely norm.

(3) Feedback current flows out of the pin.

(4) Current flows into the pin.

Electrical Characteristics (continued)

Specifications in standard type face are for $T_J = 25^\circ\text{C}$ and those in **boldface type** apply over the full **Operating Temperature Range ($T_J = -40^\circ\text{C}$ to $+125^\circ\text{C}$)**. Unless otherwise specified $V_{IN} = 2.7\text{V}$ and specification apply to both LM3500-16 and LM3500-21.

Symbol	Parameter	Conditions	Min (1)	Typ (2)	Max (1)	Units
I_{Vout}	V_{OUT} Bias Current (LM3500-16)	$V_{OUT} = 15\text{V}$, $\overline{\text{SHDN}} = V_{IN}$		260	400	μA
	V_{OUT} Bias Current (LM3500-21)	$V_{OUT} = 20\text{V}$, $\overline{\text{SHDN}} = V_{IN}$		300	460	
I_{VL}	PMOS Switch Leakage Current (LM3500-16)	$V_{OUT} = 15\text{V}$, $V_{SW} = 0\text{V}$		0.01	3	μA
	PMOS Switch Leakage Current (LM3500-21)	$V_{OUT} = 20\text{V}$, $V_{SW} = 0\text{V}$		0.01	3	
SHDN Threshold	$\overline{\text{SHDN}}$ Low			0.65	0.3	V
	$\overline{\text{SHDN}}$ High		1.1	0.65		

Typical Performance Characteristics

Switching Quiescent Current vs V_{IN}

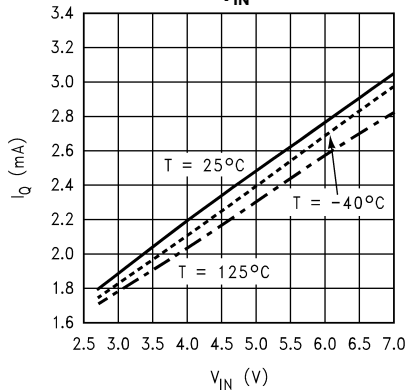

Figure 2.

Non-Switching Quiescent Current vs V_{IN}

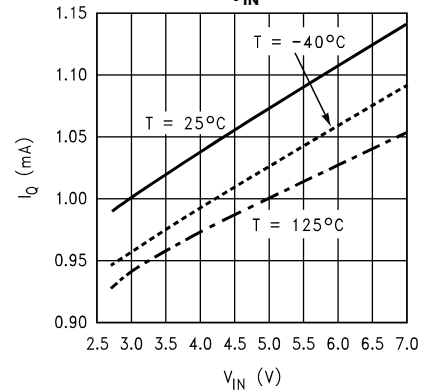

Figure 3.

2 LED Efficiency vs LED Current
L = Coilcraft DT1608C-223,
Efficiency = $100 \cdot (P_{IN} / (2V_{LED} \cdot I_{LED}))$

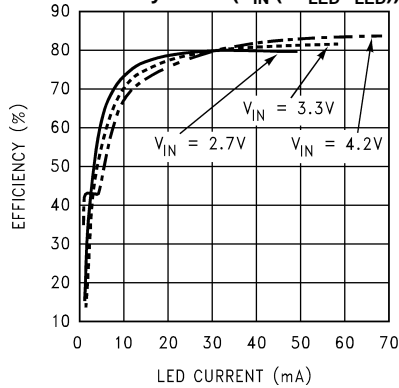

Figure 4.

2 LED Efficiency vs LED Current
L = TDK VLP4612T-220MR34,
Efficiency = $100 \cdot (P_{IN} / (2V_{LED} \cdot I_{LED}))$

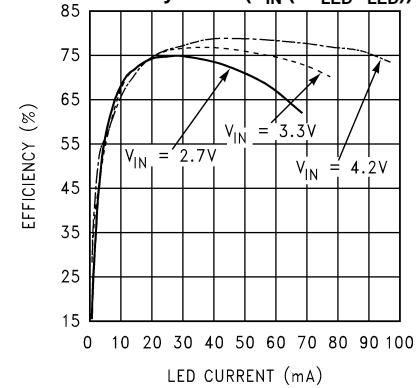

Figure 5.

3 LED Efficiency vs LED Current
L = Coilcraft DT1608C-223,
Efficiency = $100 \cdot (P_{IN} / (3V_{LED} \cdot I_{LED}))$

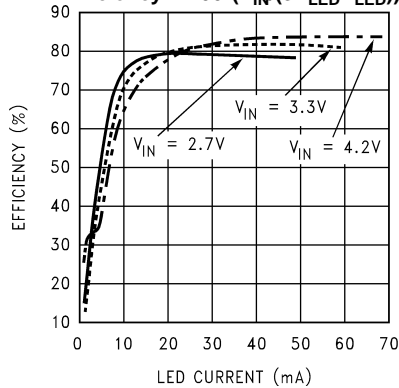

Figure 6.

3 LED Efficiency vs LED Current
L = TDK VLP4612T-220MR34,
Efficiency = $100 \cdot (P_{IN} / (3V_{LED} \cdot I_{LED}))$

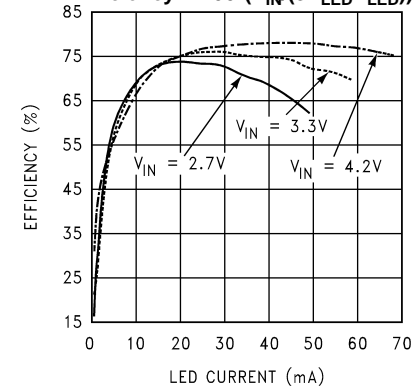

Figure 7.

Typical Performance Characteristics (continued)

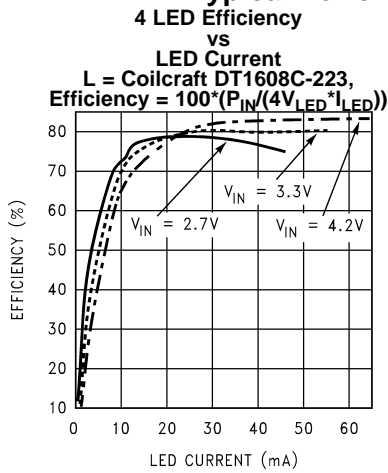

Figure 8.

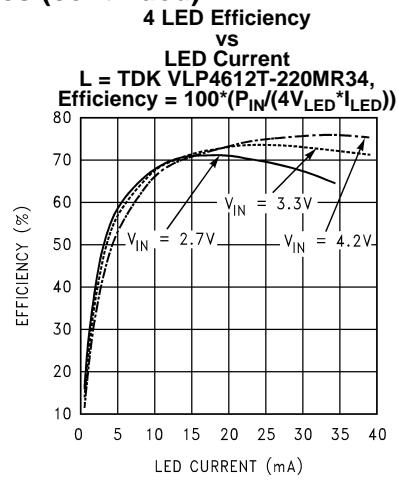

Figure 9.

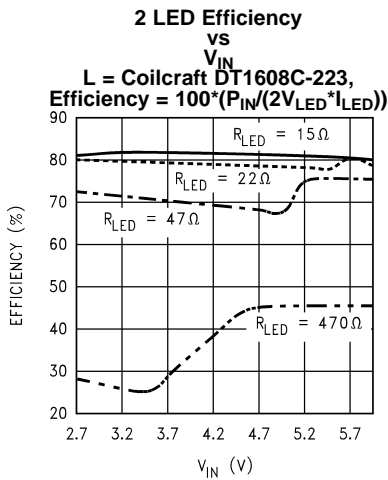

Figure 10.

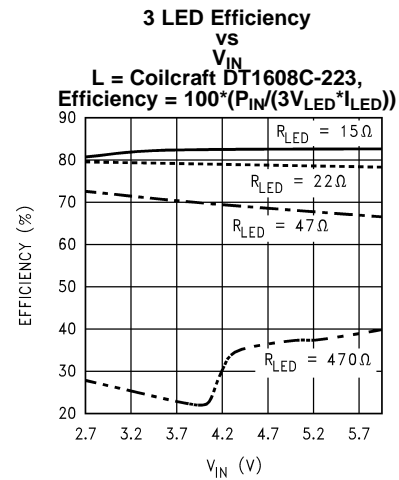

Figure 11.

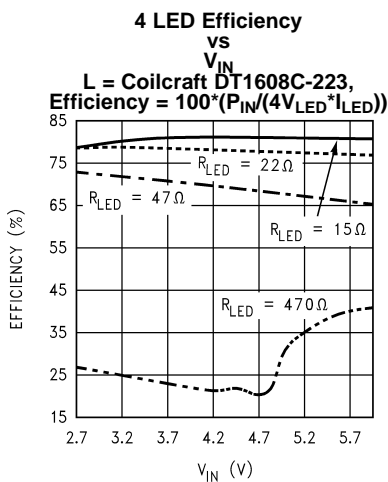

Figure 12.

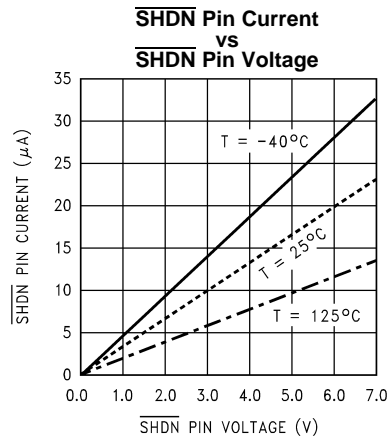
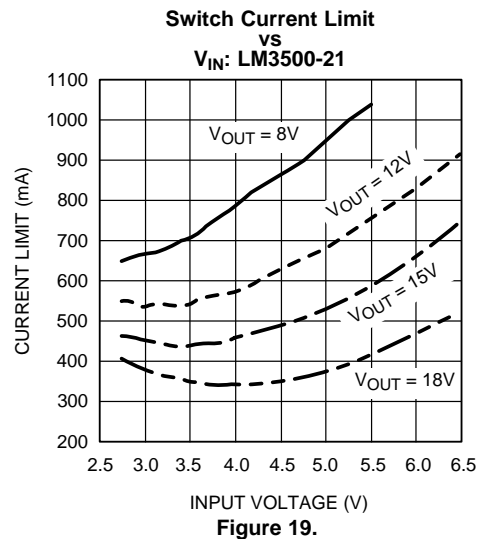
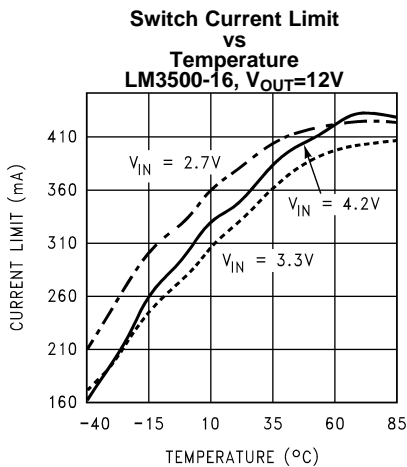
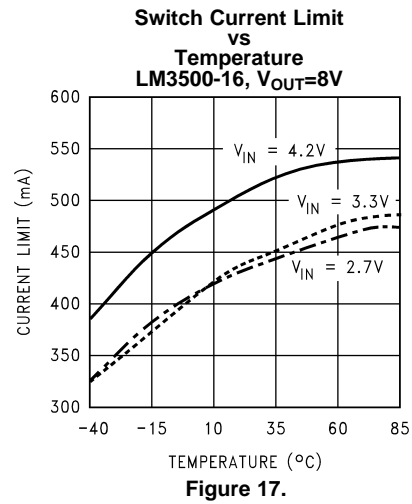
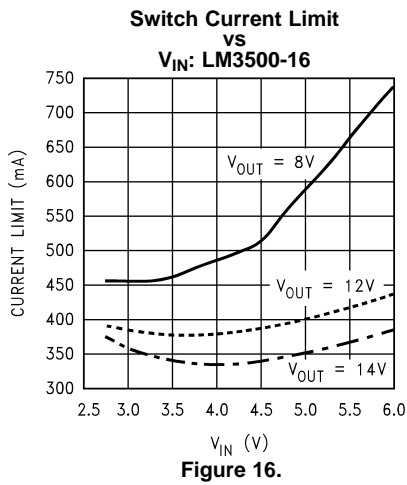
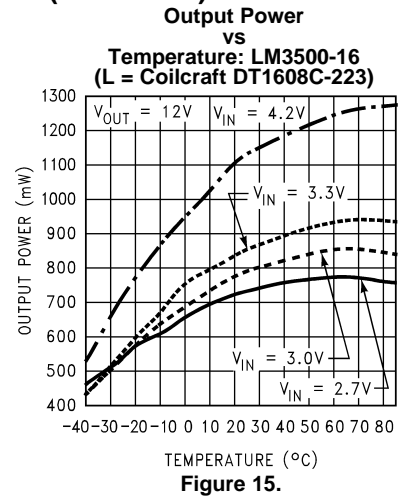
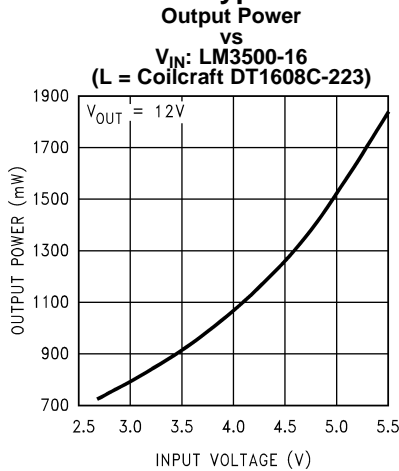

Figure 13.

Typical Performance Characteristics (continued)



Typical Performance Characteristics (continued)

Switch Current Limit vs Temperature
LM3500-21, $V_{OUT}=12V$

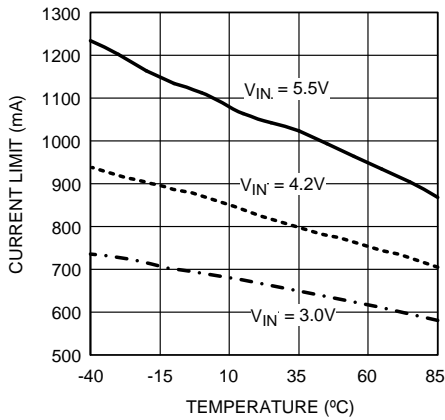

Figure 20.

Switch Current Limit vs Temperature
LM3500-21, $V_{OUT}=12V$

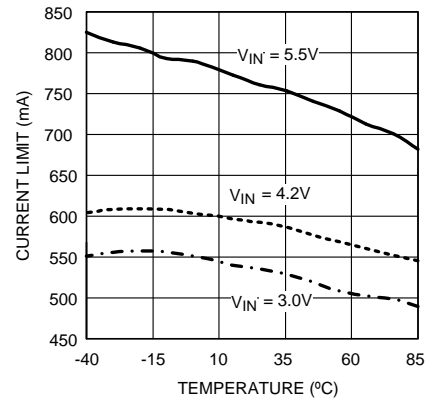

Figure 21.

Switch Current Limit vs Temperature
LM3500-21, $V_{OUT}=18V$

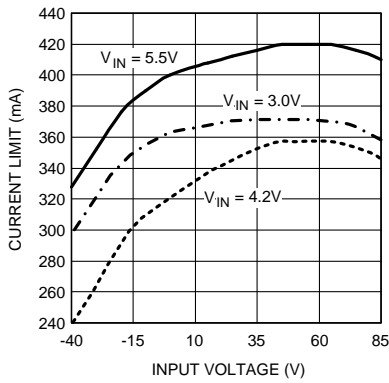

Figure 22.

Oscillator Frequency vs VIN

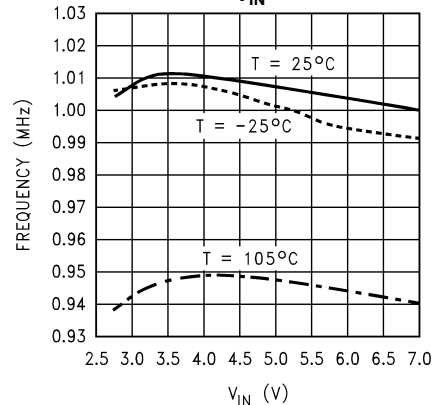

Figure 23.

VOUT DC Bias vs VOUT Voltage: LM3500-16

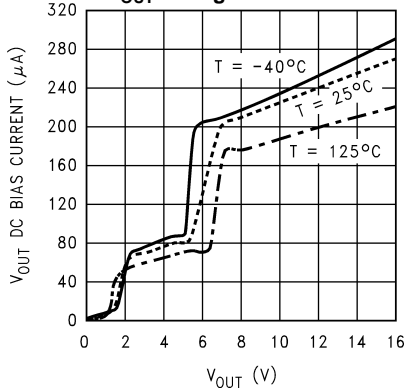

Figure 24.

VOUT DC Bias vs VOUT Voltage: LM3500-21

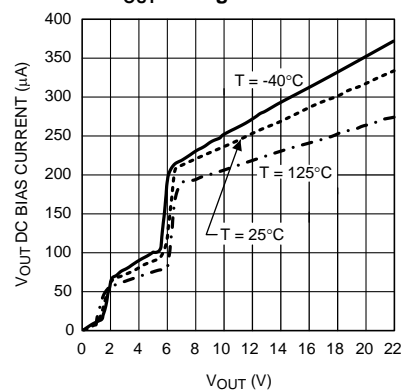

Figure 25.

Typical Performance Characteristics (continued)

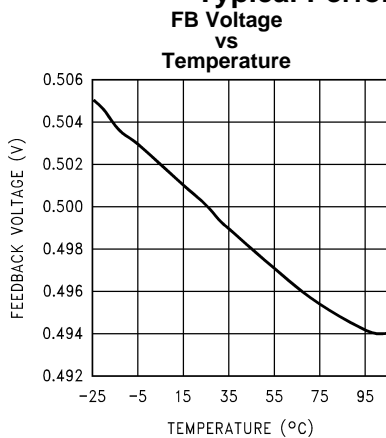

Figure 26.

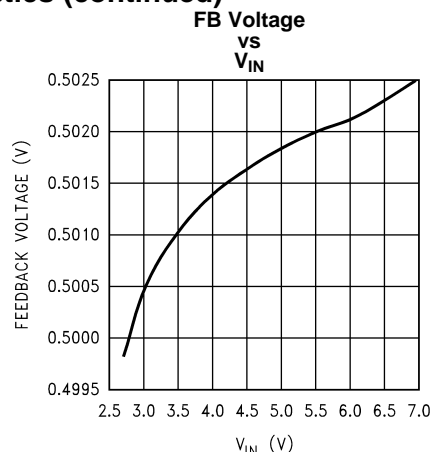

Figure 27.

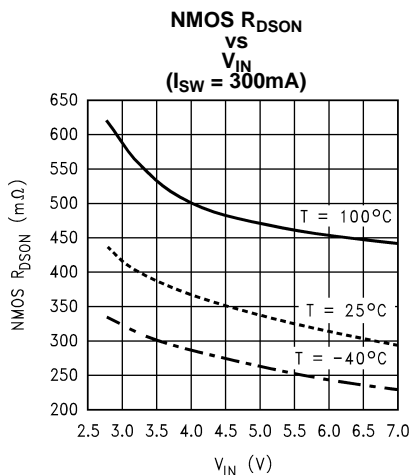

Figure 28.

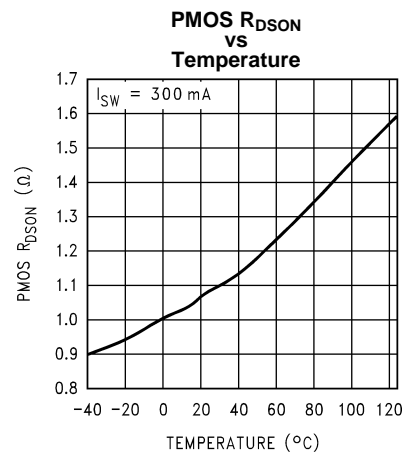
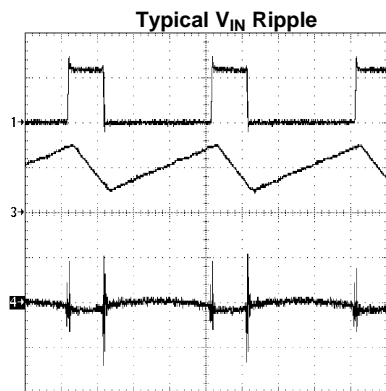
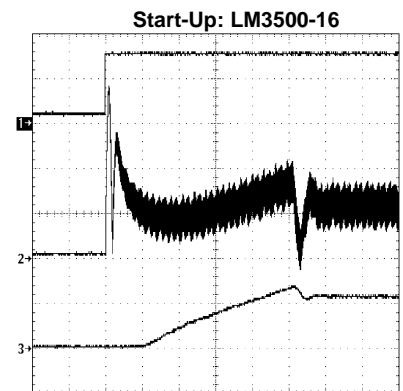

Figure 29.



LM3500-16, 3 LEDs, $R_{LED} = 22\Omega$, $V_{IN} = 3.0V$
 1) SW, 10V/div, DC
 3) I_L , 100mA/div, DC
 4) V_{IN} , 100mV/div, AC
 T = 250ns/div

Figure 30.



3 LEDs, $R_{LED} = 22\Omega$, $V_{IN} = 3.0V$
 1) SHDN, 1V/div, DC
 2) I_L , 100mA/div, DC
 3) I_{LED} , 20mA/div, DC
 T = 100µs/div

Figure 31.

Typical Performance Characteristics (continued)

Start-Up: LM3500-21

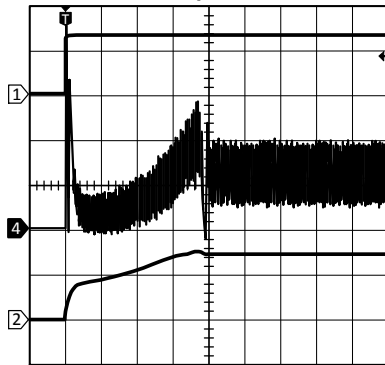

3 LEDs, $R_{LED} = 22\Omega$, $V_{IN} = 3.0V$

1) \overline{SHDN} , 1V/div, DC

4) I_L , 100mA/div, DC

2) V_{OUT} , 10/div, DC

$T = 200\mu s/div$

$V_{CONT} = 2.7V$

Figure 32.

SHDN Pin Duty Cycle Control Waveforms

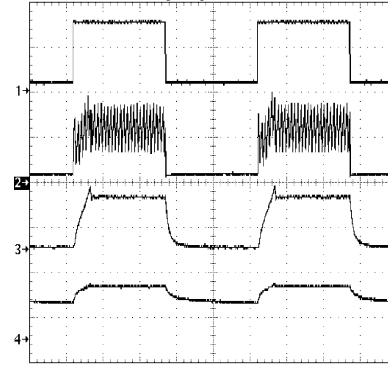

LM3500-16, 3 LEDs, $R_{LED} = 22\Omega$, $V_{IN} = 3.0V$, \overline{SHDN} frequency = 200Hz

1) \overline{SHDN} , 1V/div, DC

2) I_L , 100mA/div, DC

3) I_{LED} , 20mA/div, DC

4) V_{OUT} , 10V/div, DC

$T = 1ms/div$

Figure 33.

Typical V_{OUT} Ripple, OVP Functioning: LM3500-16

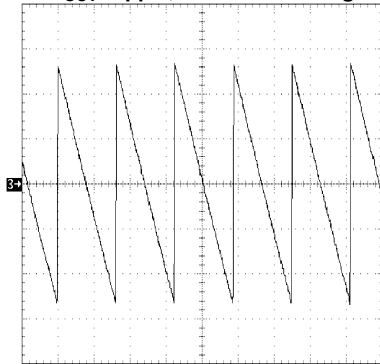

V_{OUT} open circuit and equals approximately 15V DC, $V_{IN} = 3.0V$

3) V_{OUT} , 200mV/div, AC

$T = 1ms/div$

Figure 34.

Typical V_{OUT} Ripple, OVP Functioning: LM3500-21

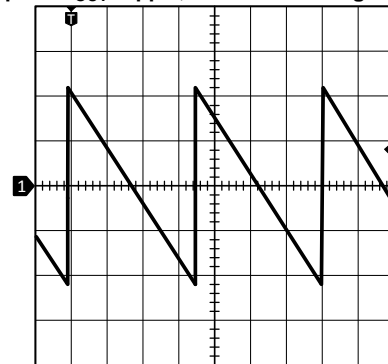

V_{OUT} open circuit and equals approximately 20V DC, $V_{IN} = 3.0V$

1) V_{OUT} , 200mV/div, AC

$T = 400\mu s/div$

Figure 35.

OPERATION

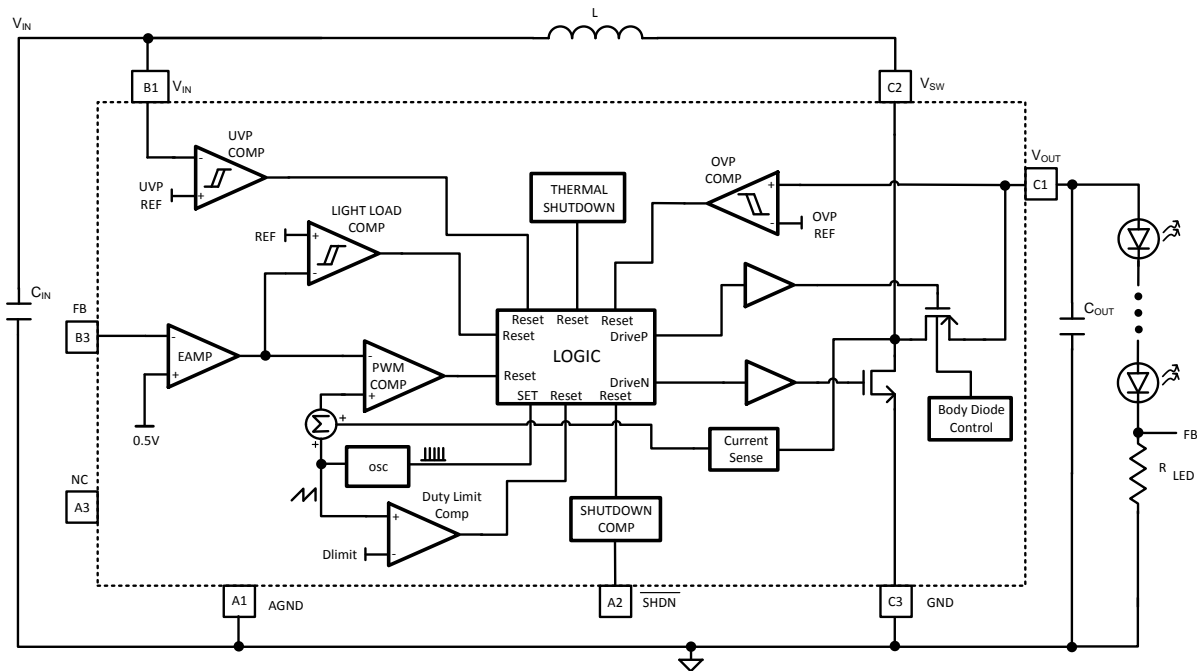

Figure 36. LM3500 Block Diagram

The LM3500 utilizes a synchronous Current Mode PWM control scheme to regulate the feedback voltage over almost all load conditions. The DC/DC controller acts as a controlled current source ideal for white LED applications. The LM3500 is internally compensated preventing the use of any external compensation components providing a compact overall solution. The operation can best be understood referring to the block diagram in Figure 36. At the start of each cycle, the oscillator sets the driver logic and turns on the NMOS power device conducting current through the inductor and turns off the PMOS power device isolating the output from the V_{SW} pin. The LED current is supplied by the output capacitor when the NMOS power device is active. During this cycle, the output voltage of the EAMP controls the current through the inductor. This voltage will increase for larger loads and decrease for smaller loads limiting the peak current in the inductor minimizing EMI radiation. The EAMP voltage is compared with a voltage ramp and the sensed switch voltage. Once this voltage reaches the EAMP output voltage, the PWM COMP will then reset the logic turning off the NMOS power device and turning on the PMOS power device. The inductor current then flows through the PMOS power device to the white LED load and output capacitor. The inductor current recharges the output capacitor and supplies the current for the white LED branches. The oscillator then sets the driver logic again repeating the process. The Duty Limit Comp is always operational preventing the NMOS power switch from being on more than one cycle and conducting large amounts of current.

The LM3500 has dedicated protection circuitry active during normal operation to protect the IC and the external components. The Thermal Shutdown circuitry turns off both the NMOS and PMOS power devices when the die temperature reaches excessive levels. The LM3500 has a UVP Comp that disables both the NMOS and PMOS power devices when battery voltages are too low preventing an on state of the power devices which could conduct large amounts of current. The OVP Comp prevents the output voltage from increasing beyond 15.5V(LM3500-16) and 20.5V(LM3500-21) when the primary white LED network is removed or if there is an LED failure, allowing the use of small (16V for LM3500-16 and 25V for LM3500-21) ceramic capacitors at the output. This comparator has hysteresis that will regulate the output voltage between 15.5V and 14.6V typically for the LM3500-16, and between 20.5V and 19.5V for the LM3500-21. The LM3500 features a shutdown mode that reduces the supply current to 0.1uA and isolates the input and output of the converter.

Application Information

ADJUSTING LED CURRENT

The White LED current is set using the following equation:

$$I_{LED} = V_{FB}/R_{LED} \quad (1)$$

The LED current can be controlled using a PWM signal on the \overline{SHDN} pin with frequencies in the range of 100Hz (greater than visible frequency spectrum) to 1kHz. For controlling LED currents down to the μA levels, it is best to use a PWM signal frequency between 200-500Hz. The LM3500 LED current can be controlled with PWM signal frequencies above 1kHz but the controllable current decreases with higher frequency. The maximum LED current would be achieved using the equation above with 100% duty cycle, ie. the \overline{SHDN} pin always high.

LED-DRIVE CAPABILITY

The maximum number of LEDs that can be driven by the LM3500 is limited by the output voltage capability of the LM3500. When using the LM3500 in the typical application configuration, with LEDs stacked in series between the V_{OUT} and FB pins, the maximum number of LEDs that can be placed in series (N_{MAX}) is dependent on the maximum LED forward voltage (V_{F-MAX}), the voltage of the LM3500 feedback pin ($V_{FB-MAX} = 0.53V$), and the minimum output over-voltage protection level of the chosen LM3500 option (LM3500-16: $OVP_{MIN} = 15V$; LM3500-21: $OVP_{MIN} = 20V$). For the circuit to function properly, the following inequality must be met:

$$(N_{MAX} \times V_{F-MAX}) + 0.53V \leq OVP_{MIN} \quad (2)$$

When inserting a value for maximum LED V_F , LED forward voltage variation over the operating temperature range should be considered. The table below provides maximum LED voltage numbers for the LM3500-16 and LM3500-21 in the typical application circuit configuration (with 3, 4, 5, 6, or 7 LEDs placed in series between the V_{OUT} and FB pins).

# of LEDs (in series)	Maximum LED V_F	
	LM3500-16	LM3500-21
3	4.82V	6.49V
4	3.61V	4.86V
5	2.89V	3.89V
6	X	3.24V
7	X	2.78V

For the LM3500 to operate properly, the output voltage must be kept above the input voltage during operation. For most applications, this requires a minimum of 2 LEDs (total of 6V or more) between the FB and V_{OUT} pins.

OUTPUT OVERVOLTAGE PROTECTION

The LM3500 contains dedicated circuitry for monitoring the output voltage. In the event that the primary LED network is disconnected from the LM3500-16, the output voltage will increase and be limited to 15.5V (typ.). There is a 900mV hysteresis associated with this circuitry which will cause the output to fluctuate between 15.5V and 14.6V (typ.) if the primary network is disconnected. In the event that the network is reconnected regulation will begin at the appropriate output voltage. The 15.5V limit allows the use of 16V $1\mu F$ ceramic output capacitors creating an overall small solution for white LED applications.

In the event that the primary LED network is disconnected from the LM3500-21, the output voltage will increase and be limited to 20.5V (typ.). There is a 1V hysteresis associated with this circuitry which will cause the output to fluctuate between 20.5V and 19.5V (typ.) if the primary network is disconnected. In the event that the network is reconnected regulation will begin at the appropriate output voltage. The 20.5V limit allows the use of 25V $1\mu F$ ceramic output capacitors.

RELIABILITY AND THERMAL SHUTDOWN

The maximum continuous pin current for the 8 pin thin DSBGA package is 535mA. When driving the device near its power output limits the V_{SW} pin can see a higher DC current than 535mA (see [INDUCTOR SELECTION](#) section for average switch current). To preserve the long term reliability of the device the average switch current should not exceed 535mA.

The LM3500 has an internal thermal shutdown function to protect the die from excessive temperatures. The thermal shutdown trip point is typically 150°C. There is a hysteresis of typically 35°C so the die temperature must decrease to approximately 115°C before the LM3500 will return to normal operation.

INDUCTOR SELECTION

The inductor used with the LM3500 must have a saturation current greater than the cycle by cycle peak inductor current (see [Table 1](#) table below). Choosing inductors with low DCR decreases power losses and increases efficiency.

The minimum inductor value required for the LM3500-16 can be calculated using the following equation:

$$L > \frac{V_{IN} R_{DSON}}{0.29} \left(\frac{D}{D'} - 1 \right) \quad (3)$$

The minimum inductor value required for the LM3500-21 can be calculated using the following equation:

$$L > \frac{V_{IN} R_{DSON}}{0.58} \left(\frac{D}{D'} - 1 \right) \quad (4)$$

For both equations above, L is in μH , V_{IN} is the input supply of the chip in Volts, R_{DSON} is the ON resistance of the NMOS power switch found in the [Typical Performance Characteristics](#) section in ohms and D is the duty cycle of the switching regulator. The above equation is only valid for D greater than or equal to 0.5. For applications where the minimum duty cycle is less than 0.5, a 22 μH inductor is the typical recommendation for use with most applications. Bench-level verification of circuit performance is required in these special cases, however. The duty cycle, D, is given by the following equation:

$$D' = \frac{V_{IN}}{V_{OUT}} = 1 - D \quad (5)$$

where V_{OUT} is the voltage at pin C1.

Table 1. Typical Peak Inductor Currents (mA)

V_{IN} (V)	# LEDs (in series)	LED Current					
		15 mA	20 mA	30 mA	40 mA	50 mA	60 mA
2.7	2	82	100	134	160	204	234
	3	118	138	190	244	294	352
	4	142	174	244	322	X	X
	5	191	232	319	413	X	X
3.3	2	76	90	116	136	172	198
	3	110	126	168	210	250	290
	4	132	158	212	270	320	X
	5	183	216	288	365	446	X
4.2	2	64	76	96	116	142	162
	3	102	116	148	180	210	246
	4	122	146	186	232	272	318
	5	179	206	263	324	388	456

The typical cycle-by-cycle peak inductor current can be calculated from the following equation:

$$I_{PK} \approx \frac{I_{OUT}}{\eta D'} + \frac{V_{IN} D}{2 L F_{SW}} \quad (6)$$

where I_{OUT} is the total load current, F_{SW} is the switching frequency, L is the inductance and η is the converter efficiency of the total driven load. A good typical number to use for η is 0.8. The value of η can vary with load and duty cycle. The average inductor current, which is also the average V_{SW} pin current, is given by the following equation:

$$I_{L(AVE)} \approx \frac{I_{OUT}}{\eta D'} \quad (7)$$

The maximum output current capability of the LM3500 can be estimated with the following equation:

$$I_{OUT} \approx \eta D' \left(I_{CL} - \frac{V_{IN} D}{2 L F_{SW}} \right) \quad (8)$$

where I_{CL} is the current limit. Some recommended inductors include but are not limited to:

Coilcraft DT1608C series

Coilcraft DO1608C series

TDK VLP4612 series

TDK VLP5610 series

TDK VLF4012A series

CAPACITOR SELECTION

Choose low ESR ceramic capacitors for the output to minimize output voltage ripple. Multilayer X7R or X5R type ceramic capacitors are the best choice. For most applications, a 1 μ F ceramic output capacitor is sufficient.

Local bypassing for the input is needed on the LM3500. Multilayer X7R or X5R ceramic capacitors with low ESR are a good choice for this as well. A 1 μ F ceramic capacitor is sufficient for most applications. However, for some applications at least a 4.7 μ F ceramic capacitor may be required for proper startup of the LM3500. Using capacitors with low ESR decreases input voltage ripple. For additional bypassing, a 100nF ceramic capacitor can be used to shunt high frequency ripple on the input. Some recommended capacitors include but are not limited to:

TDK C2012X7R1C105K

Taiyo-Yuden EMK212BJ105 G

LAYOUT CONSIDERATIONS

The input bypass capacitor C_{IN} , as shown in [Figure 36](#), must be placed close to the device and connect between the V_{IN} and GND pins. This will reduce copper trace resistance which effects the input voltage ripple of the IC. For additional input voltage filtering, a 100nF bypass capacitor can be placed in parallel with C_{IN} to shunt any high frequency noise to ground. The output capacitor, C_{OUT} , should also be placed close to the LM3500 and connected directly between the V_{OUT} and GND pins. Any copper trace connections for the C_{OUT} capacitor can increase the series resistance, which directly effects output voltage ripple and efficiency. The current setting resistor, R_{LED} , should be kept close to the FB pin to minimize copper trace connections that can inject noise into the system. The ground connection for the current setting resistor should connect directly to the GND pin. The AGND pin should connect directly to the GND pin. Not connecting the AGND pin directly, as close to the chip as possible, may affect the performance of the LM3500 and limit its current driving capability. Trace connections made to the inductor should be minimized to reduce power dissipation, EMI radiation and increase overall efficiency. It is good practice to keep the V_{SW} routing away from sensitive pins such as the FB pin. Failure to do so may inject noise into the FB pin and affect the regulation of the device. See [Figure 37](#) and [Figure 38](#) for an example of a good layout as used for the LM3500 evaluation board.

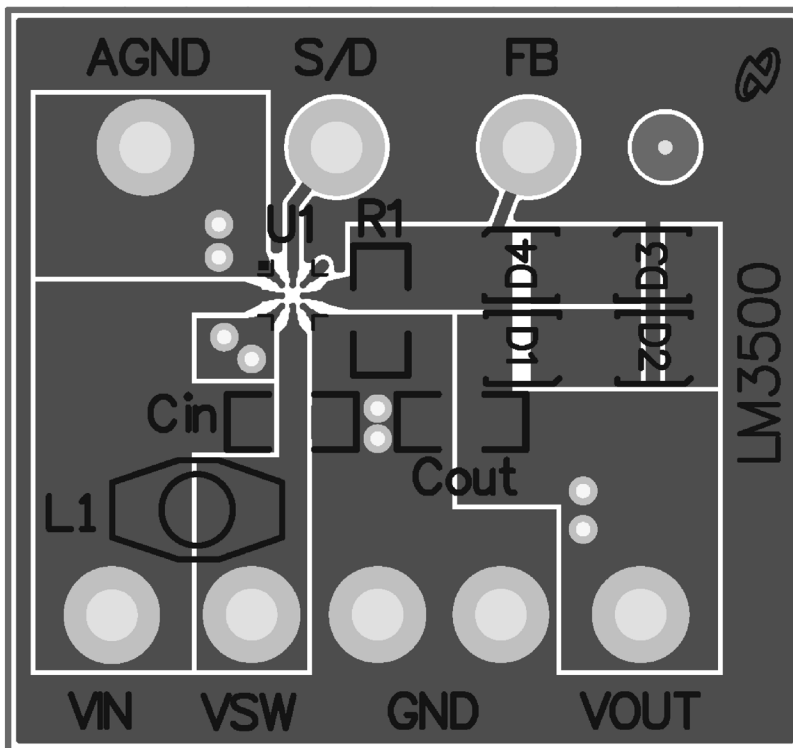

Figure 37. Evaluation Board Layout (2X Magnification)
Top Layer

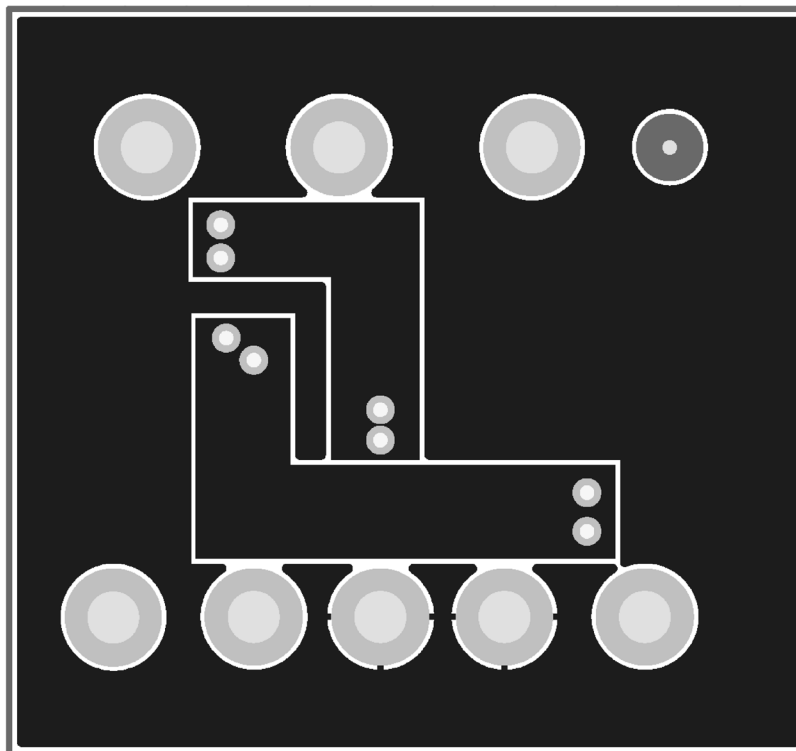

Figure 38. Evaluation Board Layout (2X Magnification)
Bottom Layer (as viewed from the top)

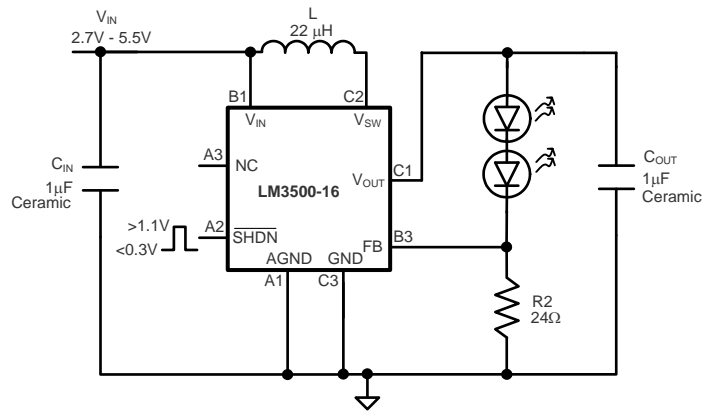

Figure 39. 2 White LED Application

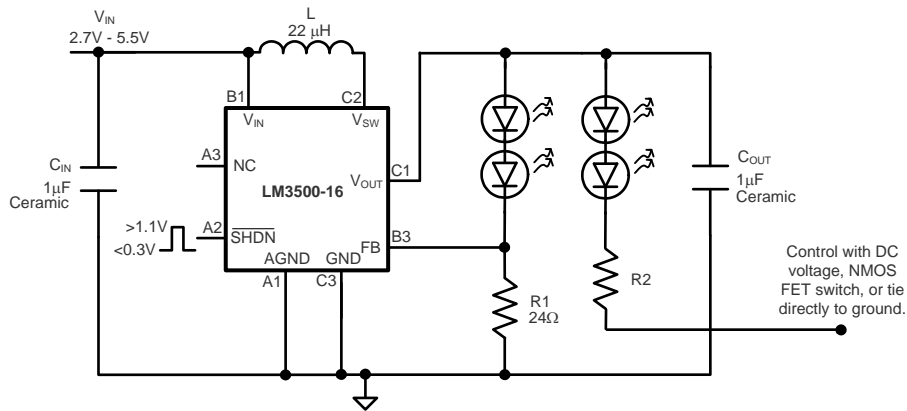

Figure 40. Multiple 2 LED String Application

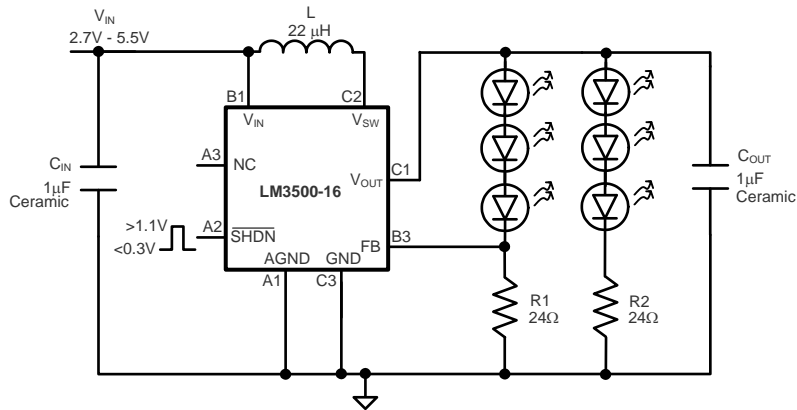

Figure 41. Multiple 3 LED String Application

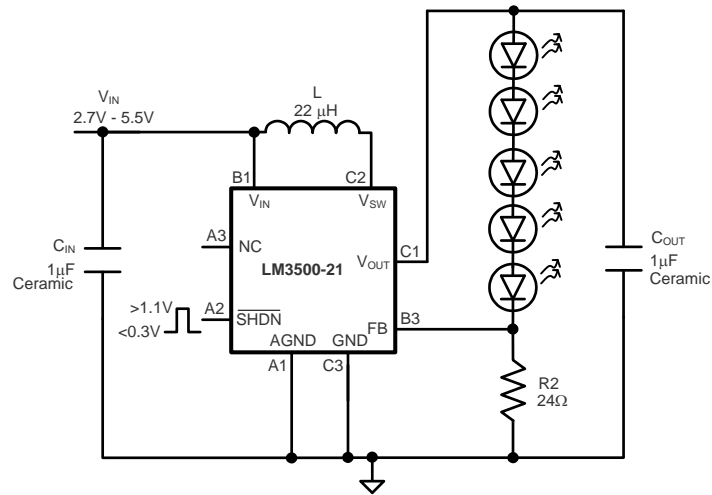





Figure 42. LM3500-21 5 LED Application

PACKAGING INFORMATION

Orderable Device	Status (1)	Package Type	Package Drawing	Pins	Package Qty	Eco Plan (2)	Lead/Ball Finish	MSL Peak Temp (3)	Op Temp (°C)	Top-Side Markings (4)	Samples
LM3500TL-16/NOPB	ACTIVE	DSBGA	YZR	8	250	Green (RoHS & no Sb/Br)	SNAGCU	Level-1-260C-UNLIM	-40 to 85	S 18	
LM3500TL-21/NOPB	ACTIVE	DSBGA	YZR	8	250	Green (RoHS & no Sb/Br)	SNAGCU	Level-1-260C-UNLIM	-40 to 85	S 23	
LM3500TLX-16/NOPB	ACTIVE	DSBGA	YZR	8	3000	Green (RoHS & no Sb/Br)	SNAGCU	Level-1-260C-UNLIM	-40 to 85	S 18	
LM3500TLX-21/NOPB	ACTIVE	DSBGA	YZR	8	3000	Green (RoHS & no Sb/Br)	SNAGCU	Level-1-260C-UNLIM	-40 to 85	S 23	

(1) The marketing status values are defined as follows:

ACTIVE: Product device recommended for new designs.

LIFEBUY: TI has announced that the device will be discontinued, and a lifetime-buy period is in effect.

NRND: Not recommended for new designs. Device is in production to support existing customers, but TI does not recommend using this part in a new design.

PREVIEW: Device has been announced but is not in production. Samples may or may not be available.

OBSOLETE: TI has discontinued the production of the device.

(2) Eco Plan - The planned eco-friendly classification: Pb-Free (RoHS), Pb-Free (RoHS Exempt), or Green (RoHS & no Sb/Br) - please check <http://www.ti.com/productcontent> for the latest availability information and additional product content details.

TBD: The Pb-Free/Green conversion plan has not been defined.

Pb-Free (RoHS): TI's terms "Lead-Free" or "Pb-Free" mean semiconductor products that are compatible with the current RoHS requirements for all 6 substances, including the requirement that lead not exceed 0.1% by weight in homogeneous materials. Where designed to be soldered at high temperatures, TI Pb-Free products are suitable for use in specified lead-free processes.

Pb-Free (RoHS Exempt): This component has a RoHS exemption for either 1) lead-based flip-chip solder bumps used between the die and package, or 2) lead-based die adhesive used between the die and leadframe. The component is otherwise considered Pb-Free (RoHS compatible) as defined above.

Green (RoHS & no Sb/Br): TI defines "Green" to mean Pb-Free (RoHS compatible), and free of Bromine (Br) and Antimony (Sb) based flame retardants (Br or Sb do not exceed 0.1% by weight in homogeneous material)

(3) MSL, Peak Temp. -- The Moisture Sensitivity Level rating according to the JEDEC industry standard classifications, and peak solder temperature.

(4) Only one of markings shown within the brackets will appear on the physical device.

Important Information and Disclaimer: The information provided on this page represents TI's knowledge and belief as of the date that it is provided. TI bases its knowledge and belief on information provided by third parties, and makes no representation or warranty as to the accuracy of such information. Efforts are underway to better integrate information from third parties. TI has taken and continues to take reasonable steps to provide representative and accurate information but may not have conducted destructive testing or chemical analysis on incoming materials and chemicals. TI and TI suppliers consider certain information to be proprietary, and thus CAS numbers and other limited information may not be available for release.

In no event shall TI's liability arising out of such information exceed the total purchase price of the TI part(s) at issue in this document sold by TI to Customer on an annual basis.

TAPE AND REEL INFORMATION

QUADRANT ASSIGNMENTS FOR PIN 1 ORIENTATION IN TAPE

*All dimensions are nominal

Device	Package Type	Package Drawing	Pins	SPQ	Reel Diameter (mm)	Reel Width W1 (mm)	A0 (mm)	B0 (mm)	K0 (mm)	P1 (mm)	W (mm)	Pin1 Quadrant
LM3500TL-16/NOPB	DSBGA	YZR	8	250	178.0	8.4	2.18	2.18	0.76	4.0	8.0	Q1
LM3500TL-21/NOPB	DSBGA	YZR	8	250	178.0	8.4	2.18	2.18	0.76	4.0	8.0	Q1
LM3500TLX-16/NOPB	DSBGA	YZR	8	3000	178.0	8.4	2.18	2.18	0.76	4.0	8.0	Q1
LM3500TLX-21/NOPB	DSBGA	YZR	8	3000	178.0	8.4	2.18	2.18	0.76	4.0	8.0	Q1

TAPE AND REEL BOX DIMENSIONS

*All dimensions are nominal

Device	Package Type	Package Drawing	Pins	SPQ	Length (mm)	Width (mm)	Height (mm)
LM3500TL-16/NOPB	DSBGA	YZR	8	250	203.0	190.0	41.0
LM3500TL-21/NOPB	DSBGA	YZR	8	250	203.0	190.0	41.0
LM3500TLX-16/NOPB	DSBGA	YZR	8	3000	206.0	191.0	90.0
LM3500TLX-21/NOPB	DSBGA	YZR	8	3000	206.0	191.0	90.0

YZR0008

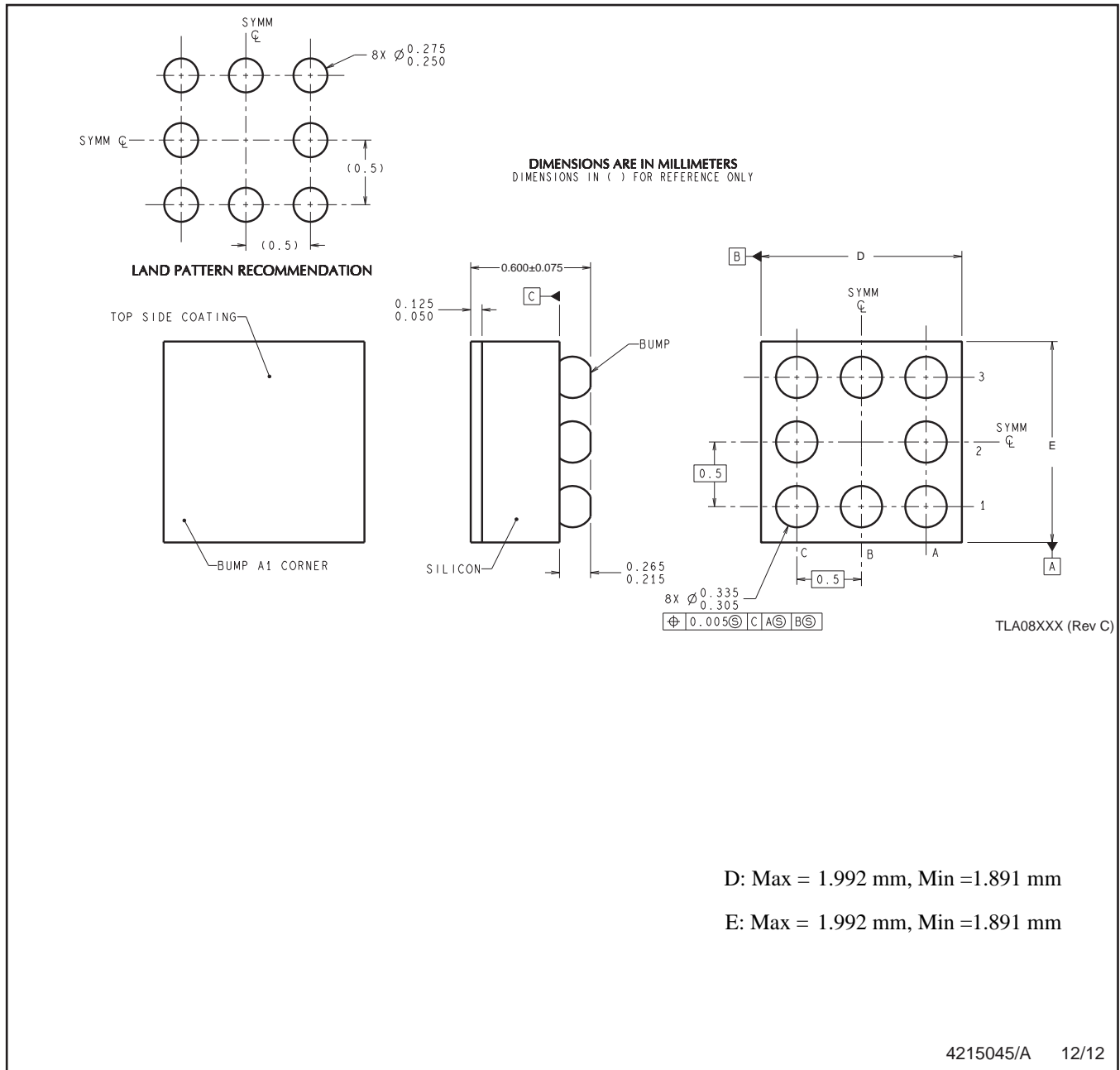

NOTES: A. All linear dimensions are in millimeters. Dimensioning and tolerancing per ASME Y14.5M-1994.
 B. This drawing is subject to change without notice.

IMPORTANT NOTICE

Texas Instruments Incorporated and its subsidiaries (TI) reserve the right to make corrections, enhancements, improvements and other changes to its semiconductor products and services per JESD46, latest issue, and to discontinue any product or service per JESD48, latest issue. Buyers should obtain the latest relevant information before placing orders and should verify that such information is current and complete. All semiconductor products (also referred to herein as "components") are sold subject to TI's terms and conditions of sale supplied at the time of order acknowledgment.

TI warrants performance of its components to the specifications applicable at the time of sale, in accordance with the warranty in TI's terms and conditions of sale of semiconductor products. Testing and other quality control techniques are used to the extent TI deems necessary to support this warranty. Except where mandated by applicable law, testing of all parameters of each component is not necessarily performed.

TI assumes no liability for applications assistance or the design of Buyers' products. Buyers are responsible for their products and applications using TI components. To minimize the risks associated with Buyers' products and applications, Buyers should provide adequate design and operating safeguards.

TI does not warrant or represent that any license, either express or implied, is granted under any patent right, copyright, mask work right, or other intellectual property right relating to any combination, machine, or process in which TI components or services are used. Information published by TI regarding third-party products or services does not constitute a license to use such products or services or a warranty or endorsement thereof. Use of such information may require a license from a third party under the patents or other intellectual property of the third party, or a license from TI under the patents or other intellectual property of TI.

Reproduction of significant portions of TI information in TI data books or data sheets is permissible only if reproduction is without alteration and is accompanied by all associated warranties, conditions, limitations, and notices. TI is not responsible or liable for such altered documentation. Information of third parties may be subject to additional restrictions.

Resale of TI components or services with statements different from or beyond the parameters stated by TI for that component or service voids all express and any implied warranties for the associated TI component or service and is an unfair and deceptive business practice. TI is not responsible or liable for any such statements.

Buyer acknowledges and agrees that it is solely responsible for compliance with all legal, regulatory and safety-related requirements concerning its products, and any use of TI components in its applications, notwithstanding any applications-related information or support that may be provided by TI. Buyer represents and agrees that it has all the necessary expertise to create and implement safeguards which anticipate dangerous consequences of failures, monitor failures and their consequences, lessen the likelihood of failures that might cause harm and take appropriate remedial actions. Buyer will fully indemnify TI and its representatives against any damages arising out of the use of any TI components in safety-critical applications.

In some cases, TI components may be promoted specifically to facilitate safety-related applications. With such components, TI's goal is to help enable customers to design and create their own end-product solutions that meet applicable functional safety standards and requirements. Nonetheless, such components are subject to these terms.

No TI components are authorized for use in FDA Class III (or similar life-critical medical equipment) unless authorized officers of the parties have executed a special agreement specifically governing such use.

Only those TI components which TI has specifically designated as military grade or "enhanced plastic" are designed and intended for use in military/aerospace applications or environments. Buyer acknowledges and agrees that any military or aerospace use of TI components which have **not** been so designated is solely at the Buyer's risk, and that Buyer is solely responsible for compliance with all legal and regulatory requirements in connection with such use.

TI has specifically designated certain components as meeting ISO/TS16949 requirements, mainly for automotive use. In any case of use of non-designated products, TI will not be responsible for any failure to meet ISO/TS16949.

Products

Audio	www.ti.com/audio
Amplifiers	amplifier.ti.com
Data Converters	dataconverter.ti.com
DLP® Products	www.dlp.com
DSP	dsp.ti.com
Clocks and Timers	www.ti.com/clocks
Interface	interface.ti.com
Logic	logic.ti.com
Power Mgmt	power.ti.com
Microcontrollers	microcontroller.ti.com
RFID	www.ti-rfid.com
OMAP Applications Processors	www.ti.com/omap
Wireless Connectivity	www.ti.com/wirelessconnectivity

Applications

Automotive and Transportation	www.ti.com/automotive
Communications and Telecom	www.ti.com/communications
Computers and Peripherals	www.ti.com/computers
Consumer Electronics	www.ti.com/consumer-apps
Energy and Lighting	www.ti.com/energy
Industrial	www.ti.com/industrial
Medical	www.ti.com/medical
Security	www.ti.com/security
Space, Avionics and Defense	www.ti.com/space-avionics-defense
Video and Imaging	www.ti.com/video

TI E2E Community

e2e.ti.com